

INSTRUKCJA MONTAŻU INSTALLATION INSTRUCTIONS

nr kat. 0507
art. N° 0507

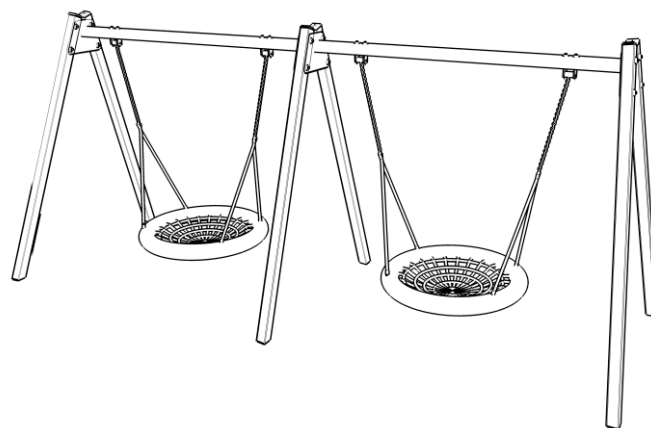

NARZĘDZIA tools

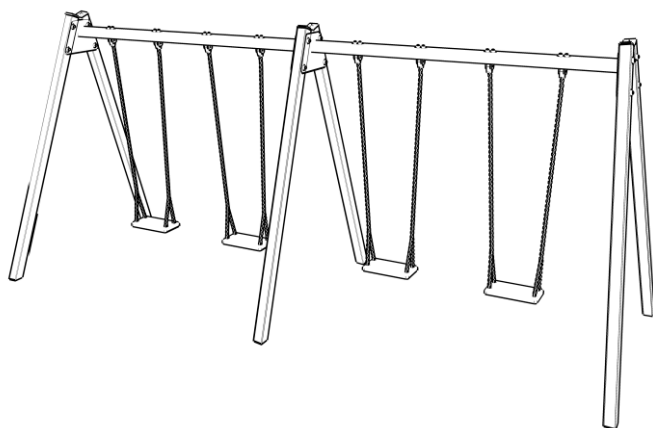
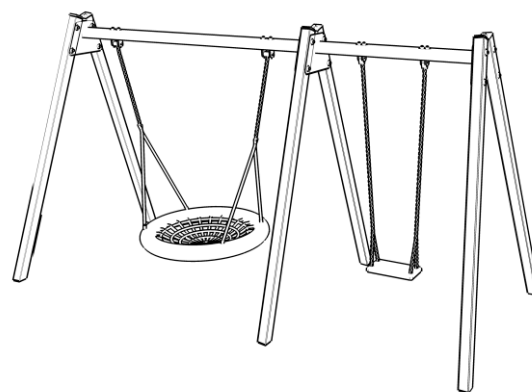
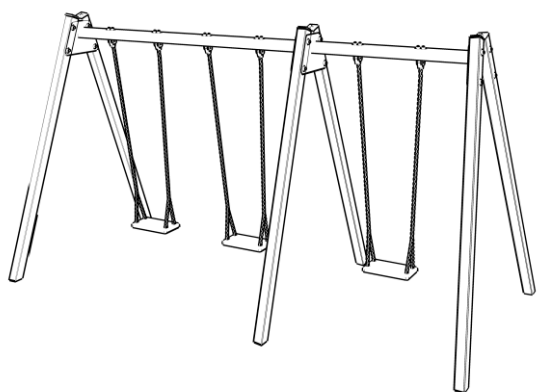
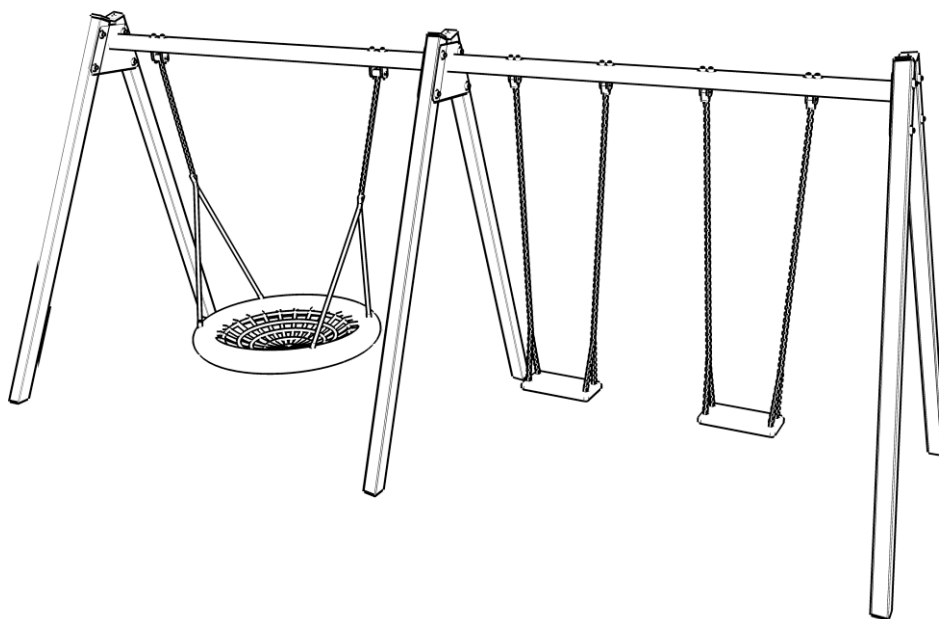

STREFA BEZPIECZEŃSTWA

safety zone

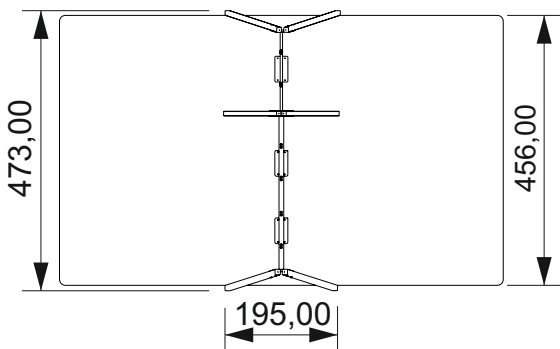
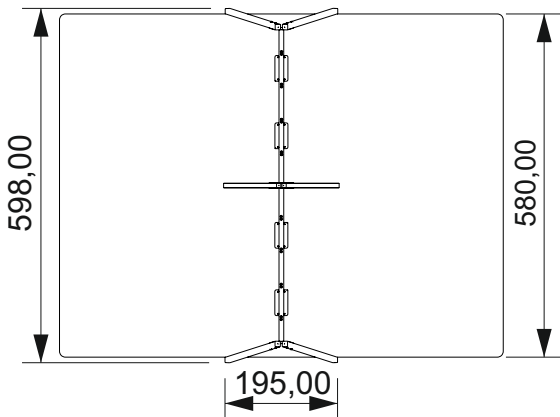
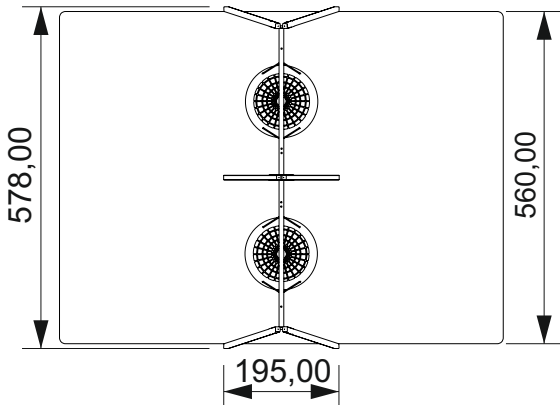
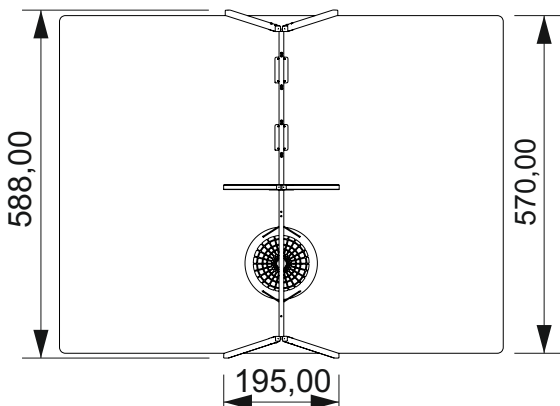
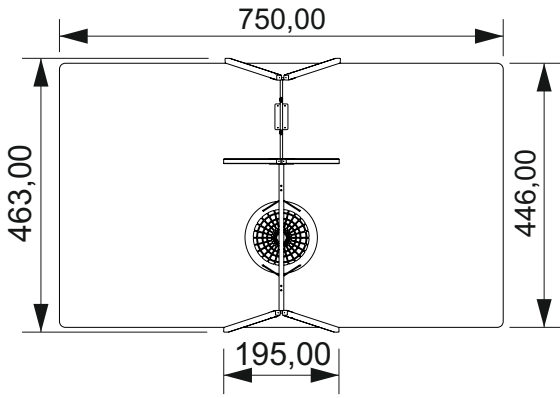

FUNDAMENTY

basement

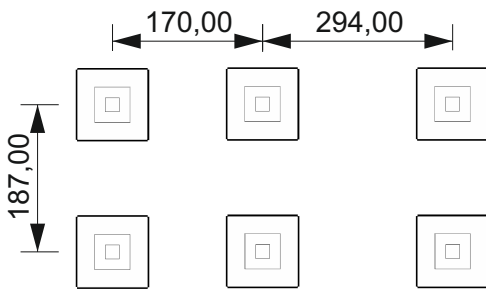
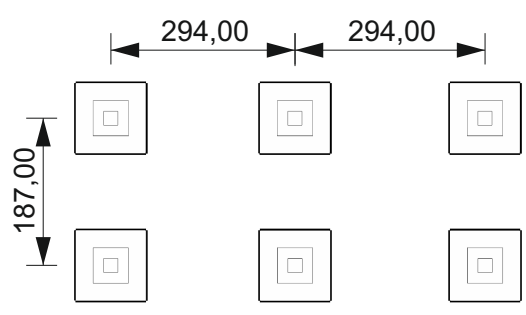
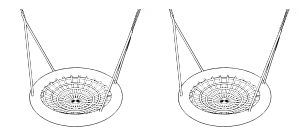
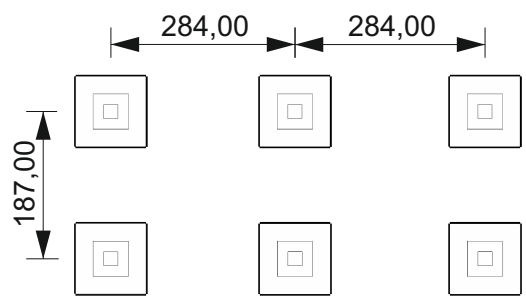
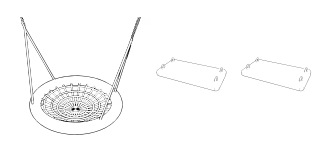
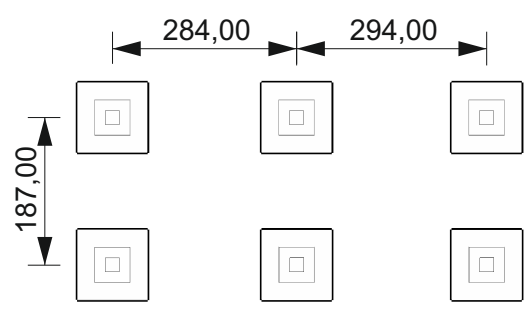
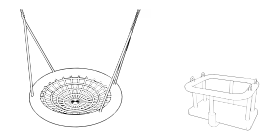
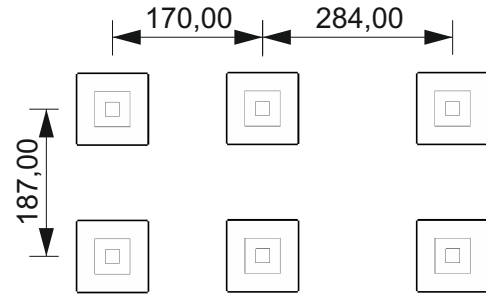

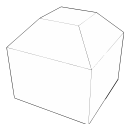

6x

0,1 m³



48h

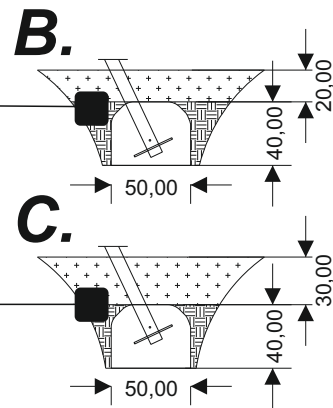
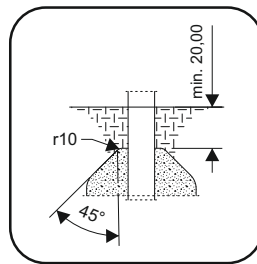
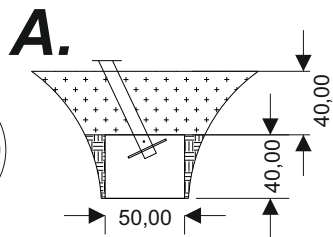

ELEMENTY SKŁADOWE

components

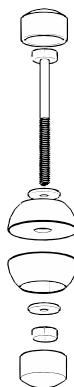

1101 M10x120

12x

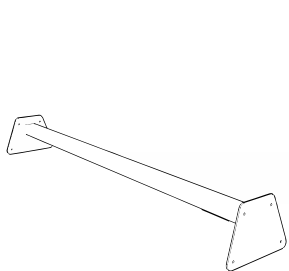

2x

1201



6x

1202

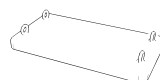

2x

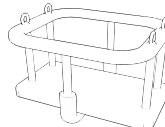

1203

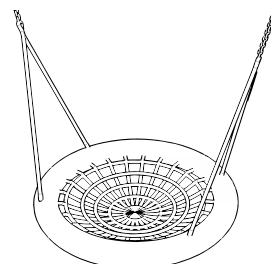

2x

1204

1

17

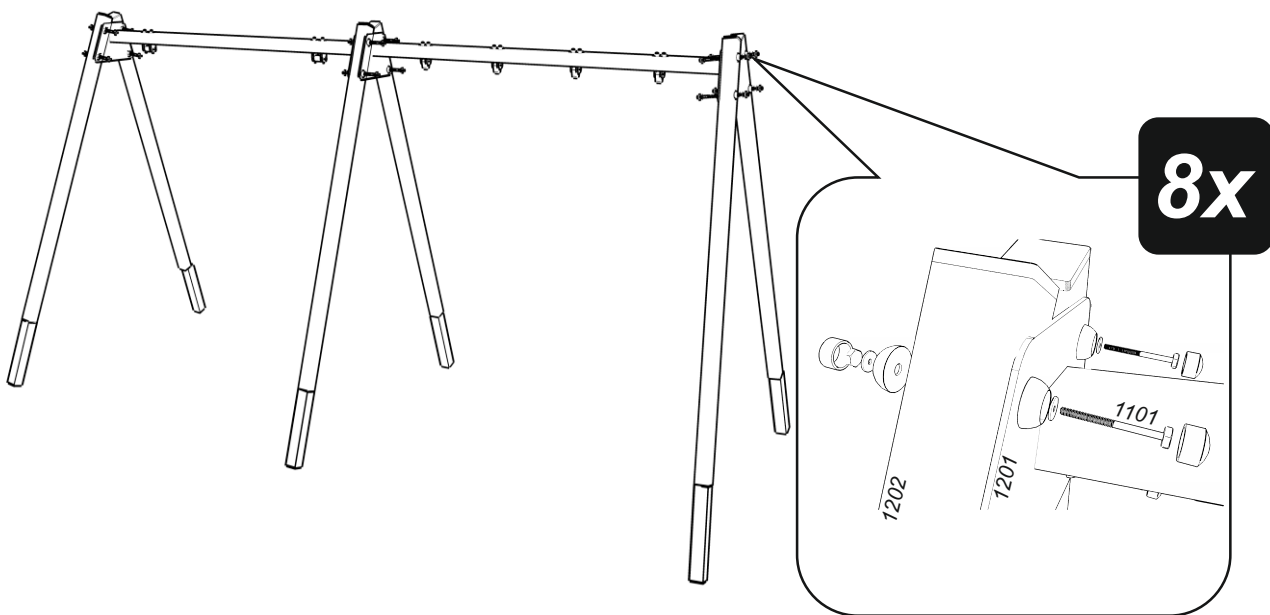

8x

2

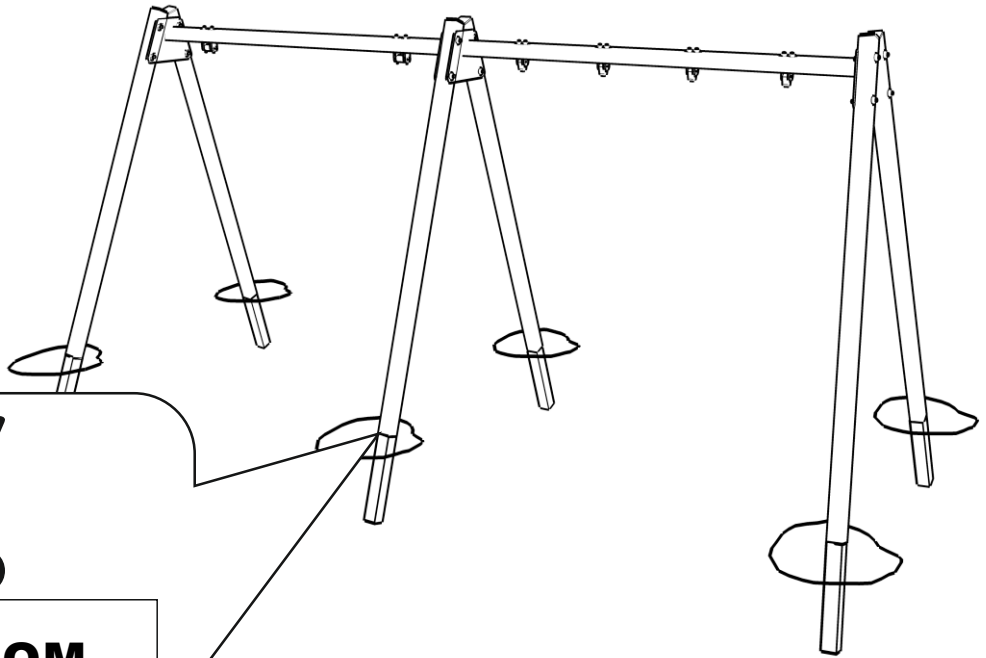

**POZIOM
GRUNTU**
(zgodnie z PN-EN 1177)

ground level

3

