

INSTRUKCJA MONTAŻU INSTALLATION INSTRUCTIONS

nr kat. 0209
art. N° 0209

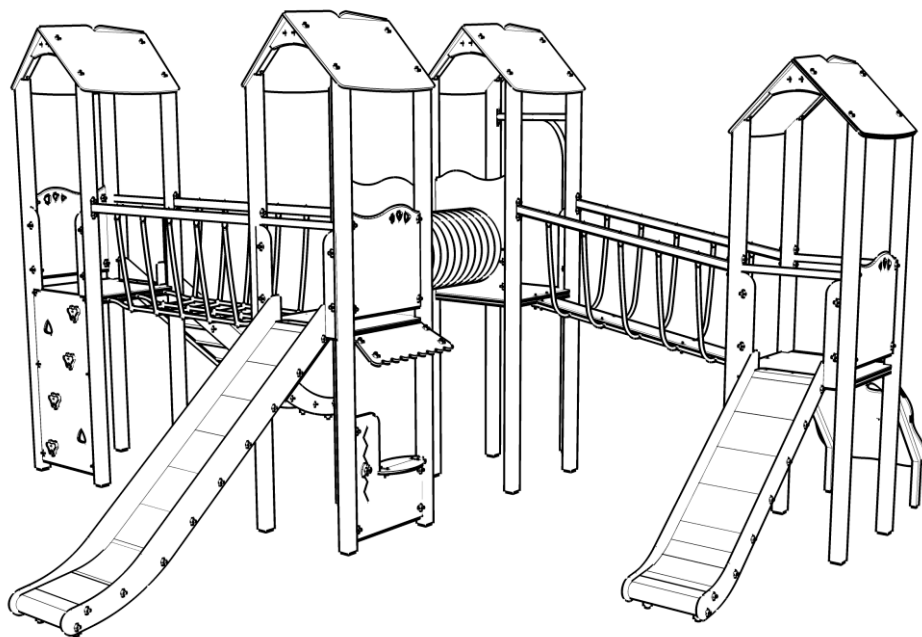

STREFA BEZPIECZEŃSTWA safety zone

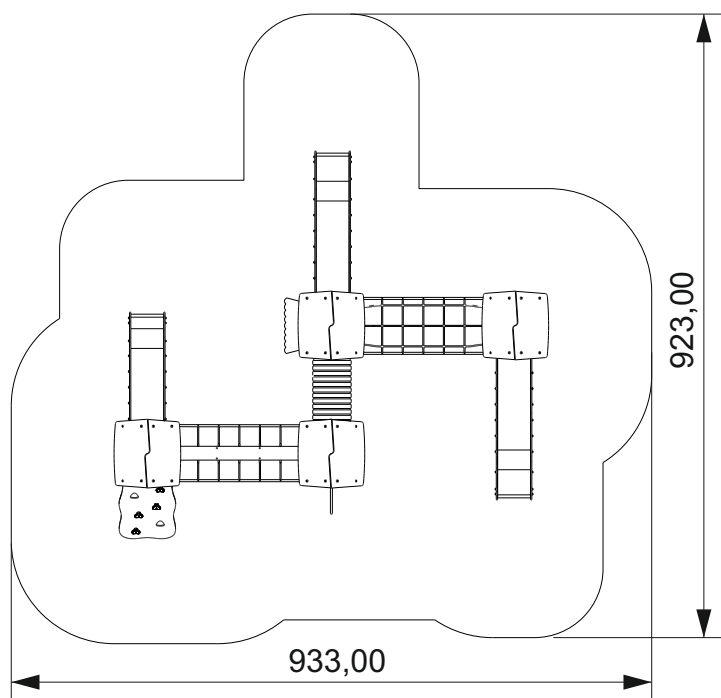

WYMIARY URZĄDZENIA dimensions

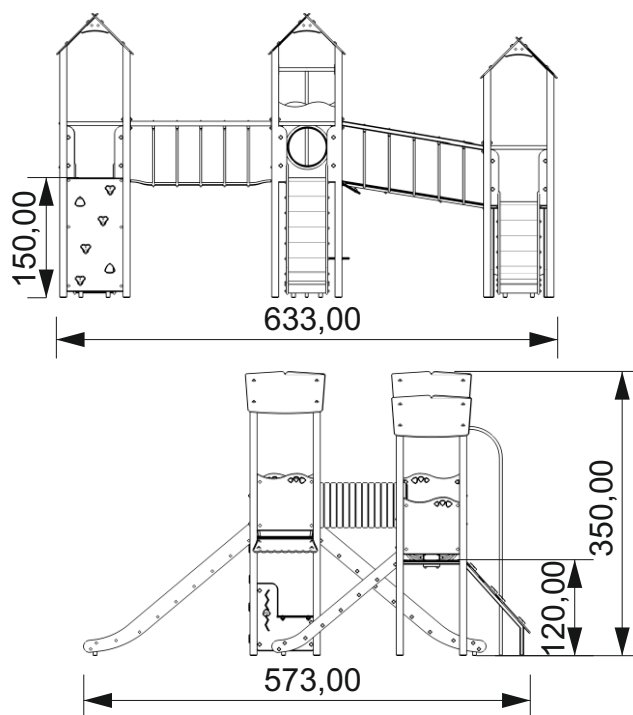

NARZĘDZIA tools

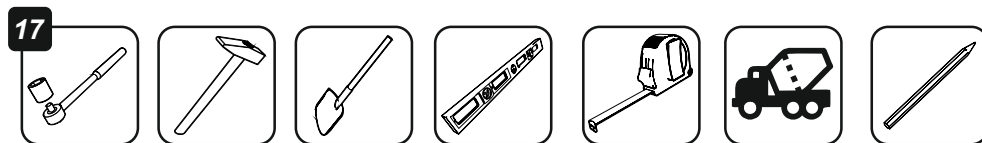

FUNDAMENTY

basement

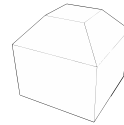
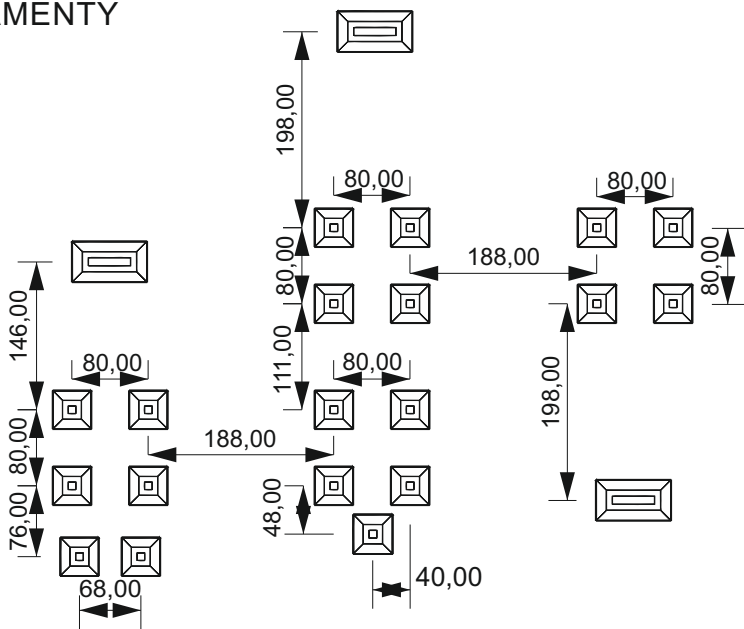

22x

0,06 m³



48h

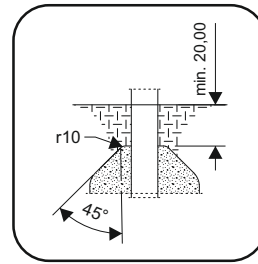

A.

B.

C.

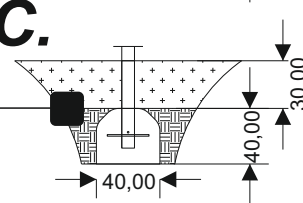
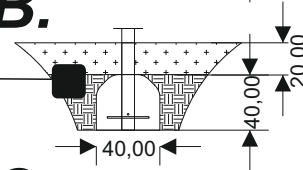
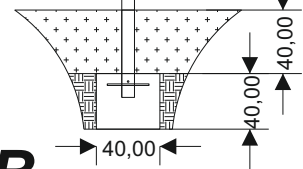

ELEMENTY SKŁADOWE

components

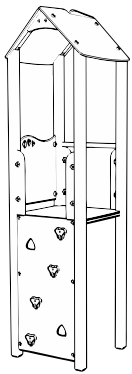
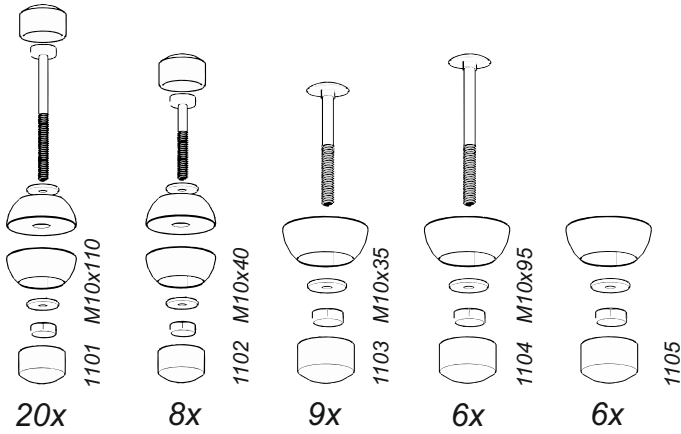

1x

1201



1x

1202

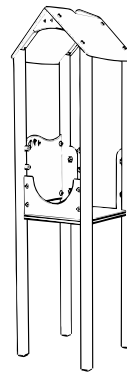

1x

1203

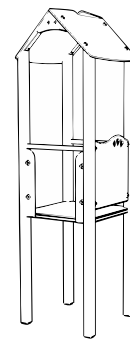

1x

1204

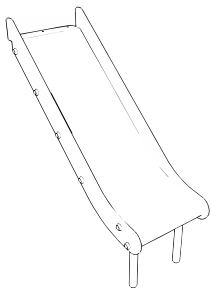

2x

1205

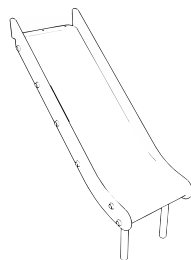

1x

1206

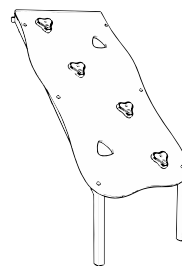

1x

1207

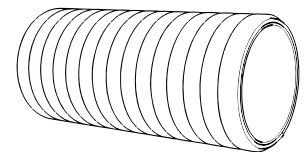

1x

1208

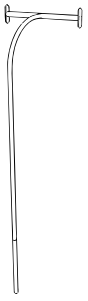

1x

1209

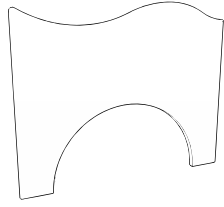

2x

1210

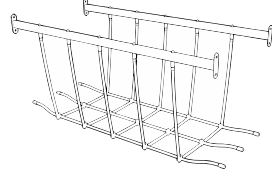

1x

1211

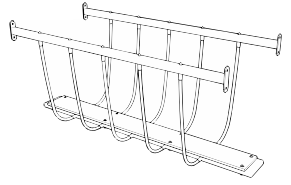

2x

1212

1

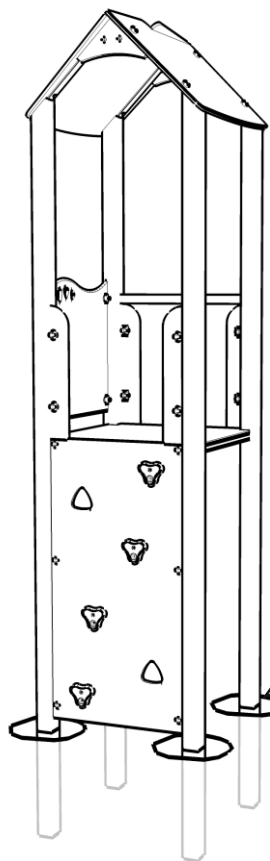
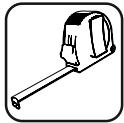

!

**POZIOM
GRUNTU**
(zgodnie z PN-EN 1177)

ground level

2

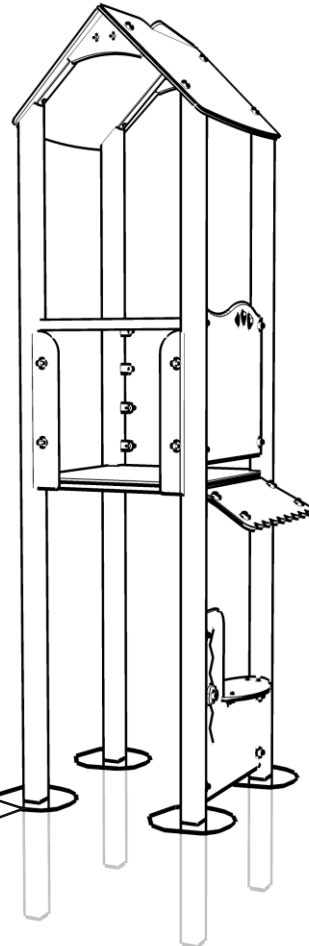
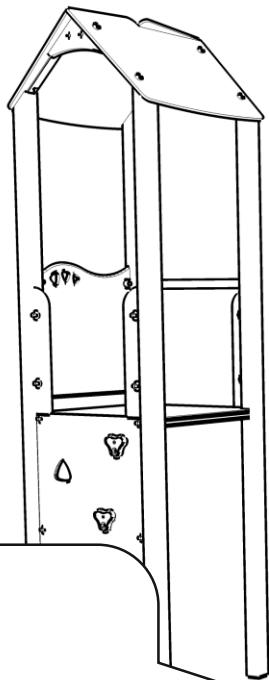

!

**POZIOM
GRUNTU**
(zgodnie z PN-EN 1177)

ground level

3



8x

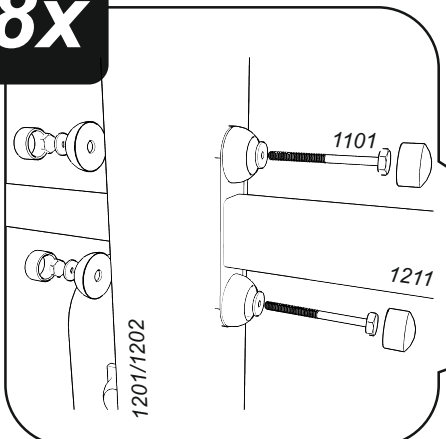

6x

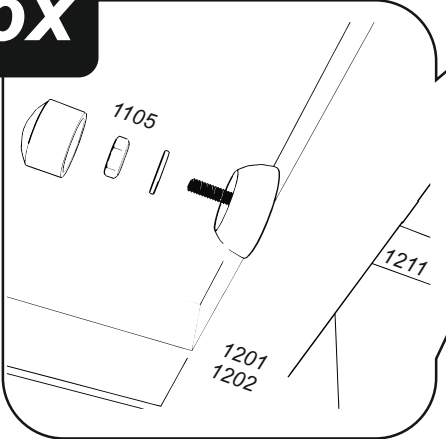

4

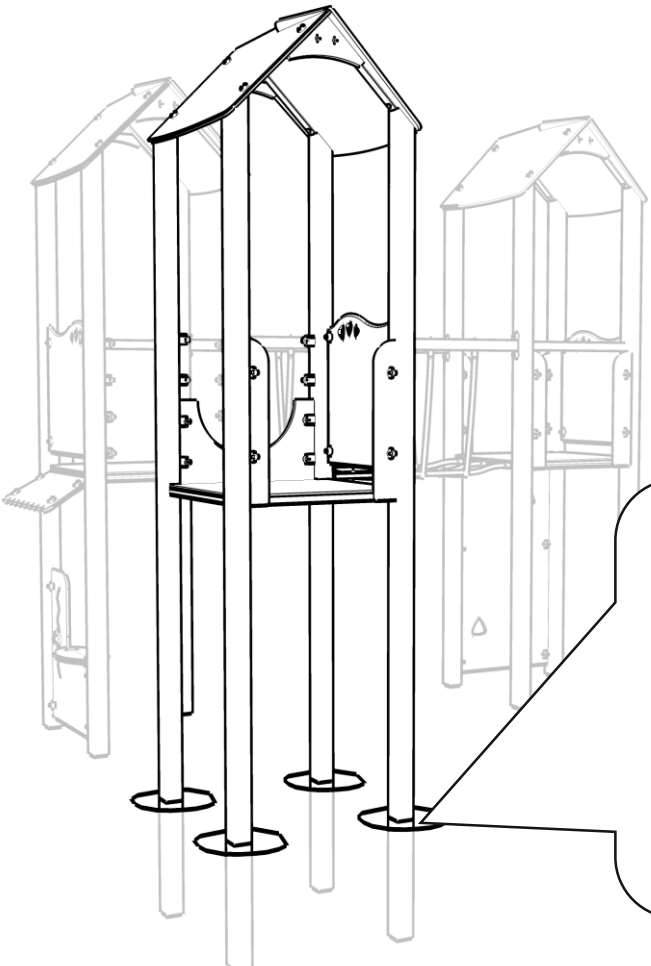
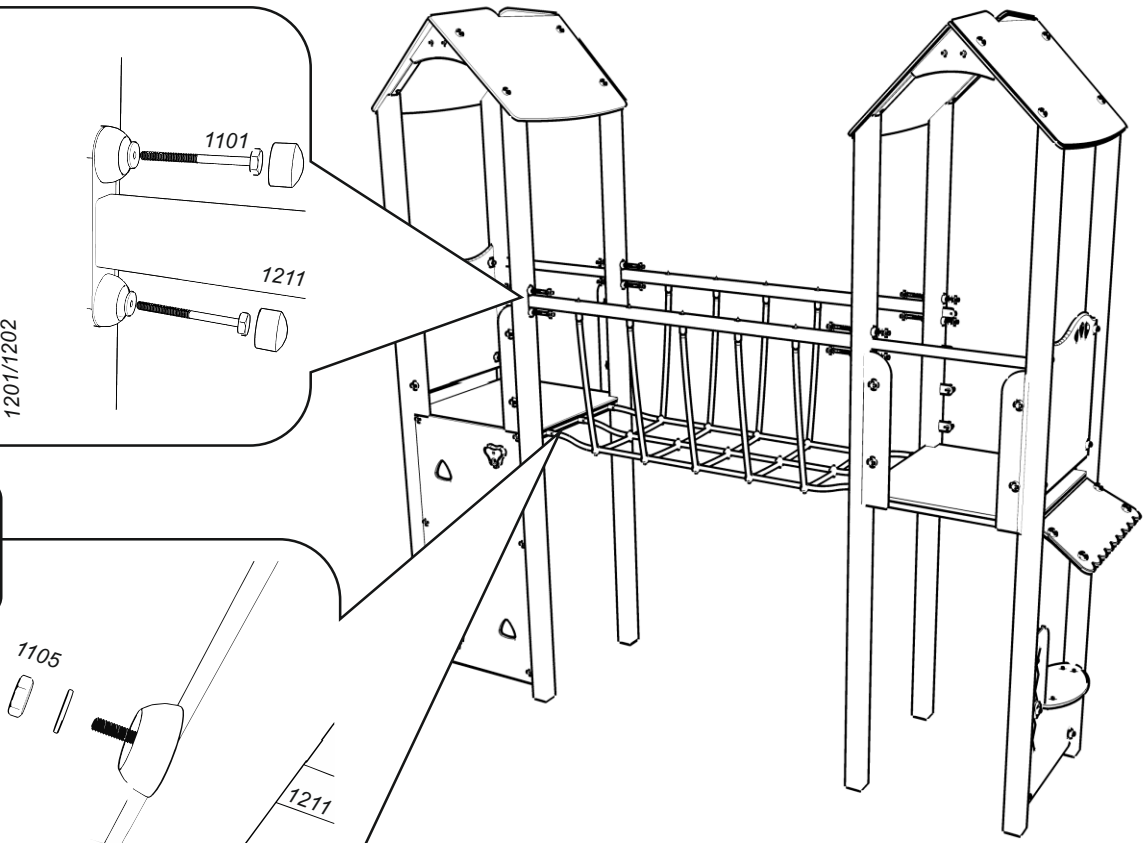
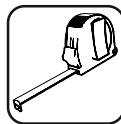
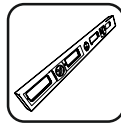

!

**POZIOM
GRUNTU**
(zgodnie z PN-EN 1177)

ground level

5

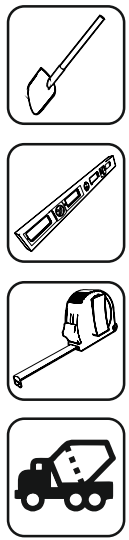

!

**POZIOM
GRUNTU**
(zgodnie z PN-EN 1177)

ground level

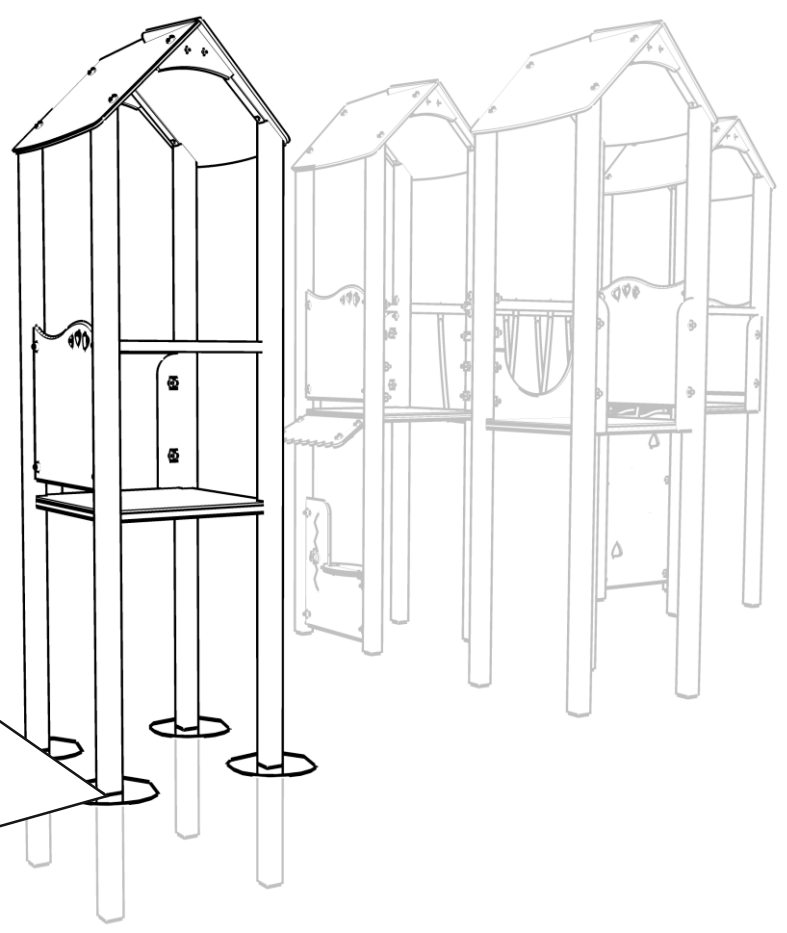

6

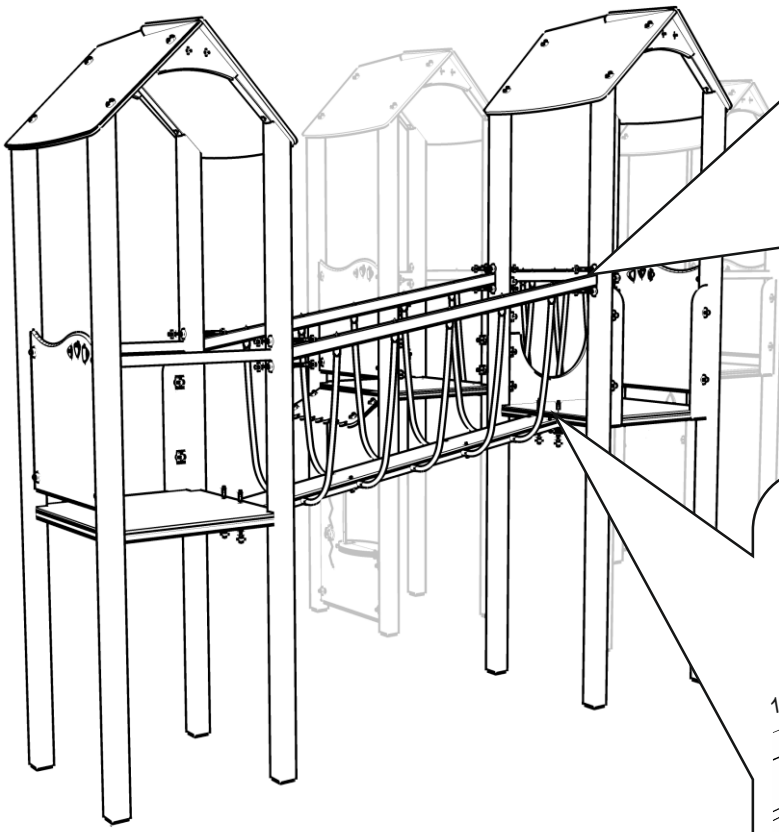
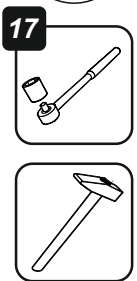

8x

1101

1212

1203/1204

4x

1104

1104

1203/1204

1212

7

2x

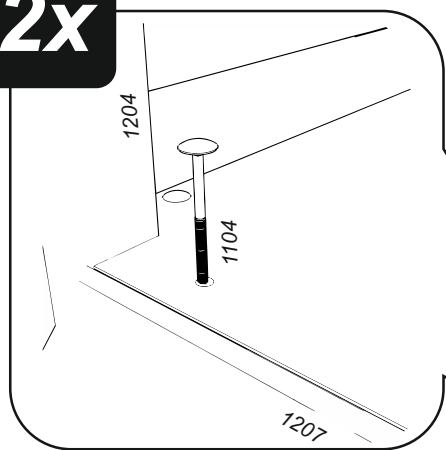
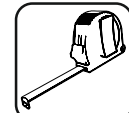
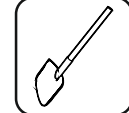

!

POZIOM GRUNTU
(zgodnie z PN-EN 1177)

ground level

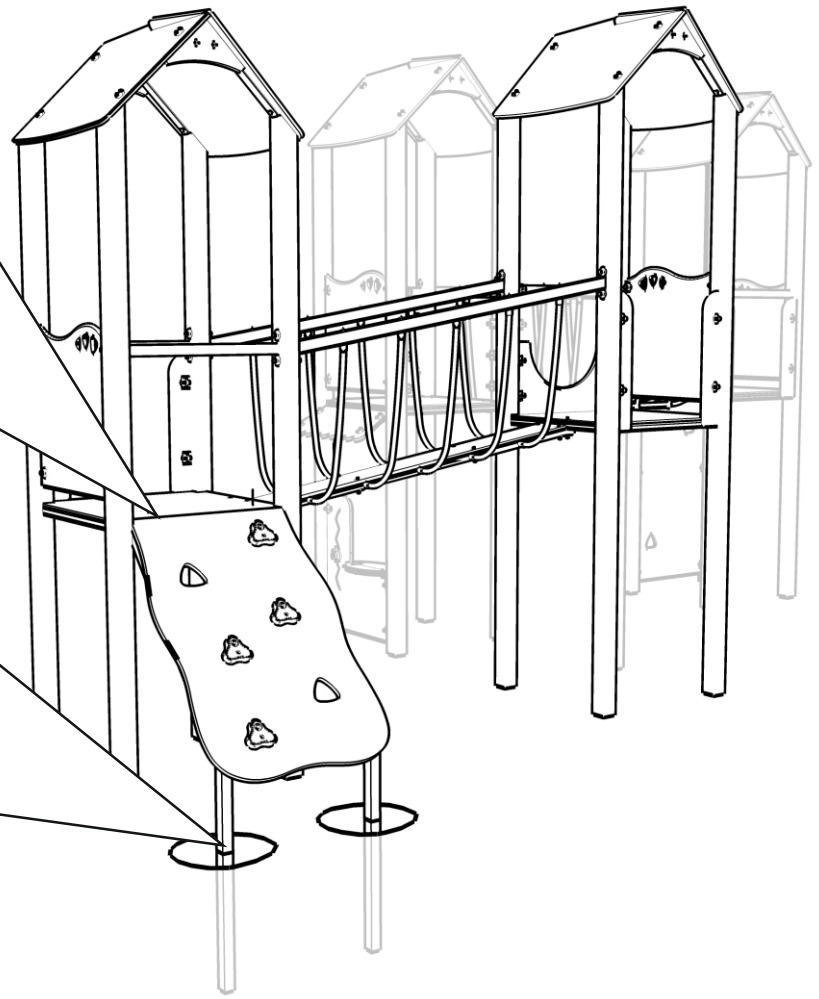

8

4x

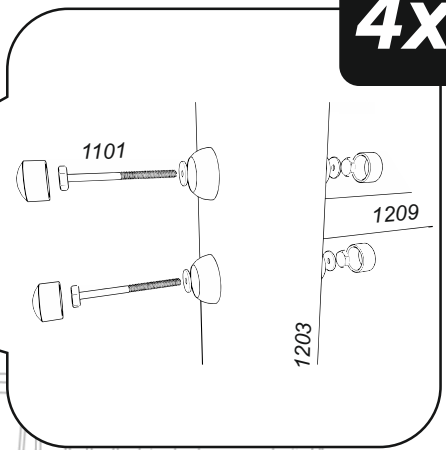
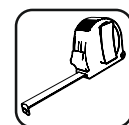
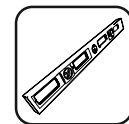
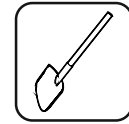

!

POZIOM GRUNTU
(zgodnie z PN-EN 1177)

ground level

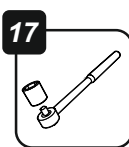

9

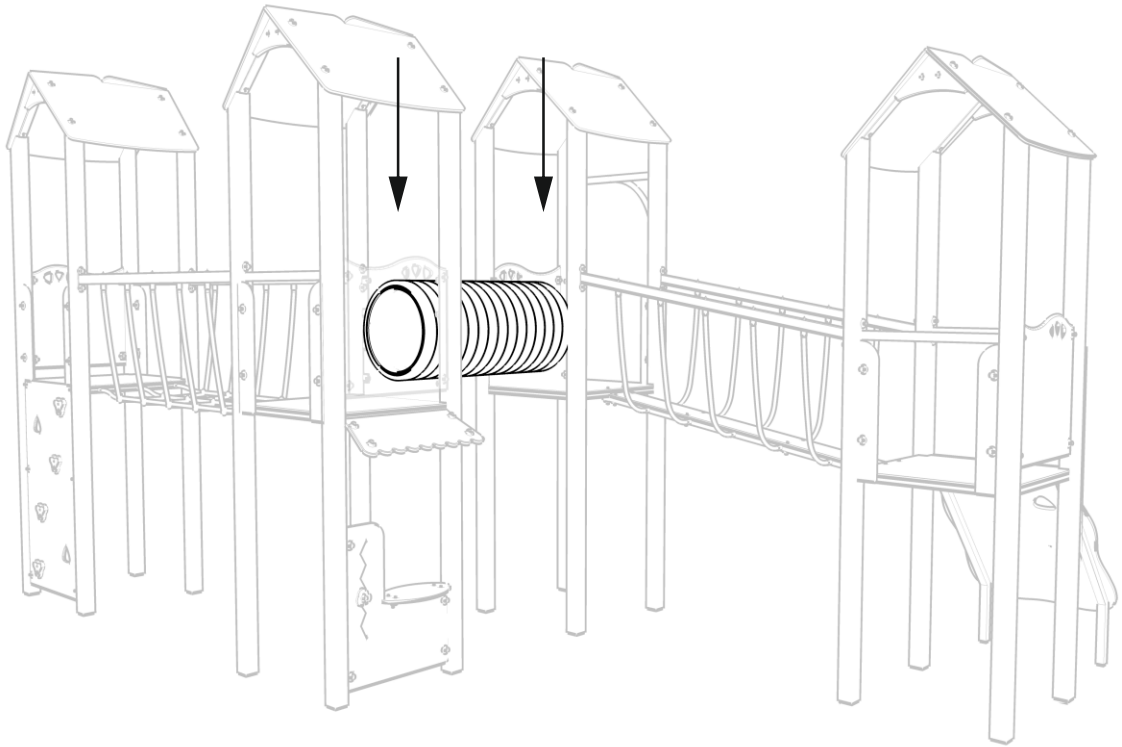

10



8x

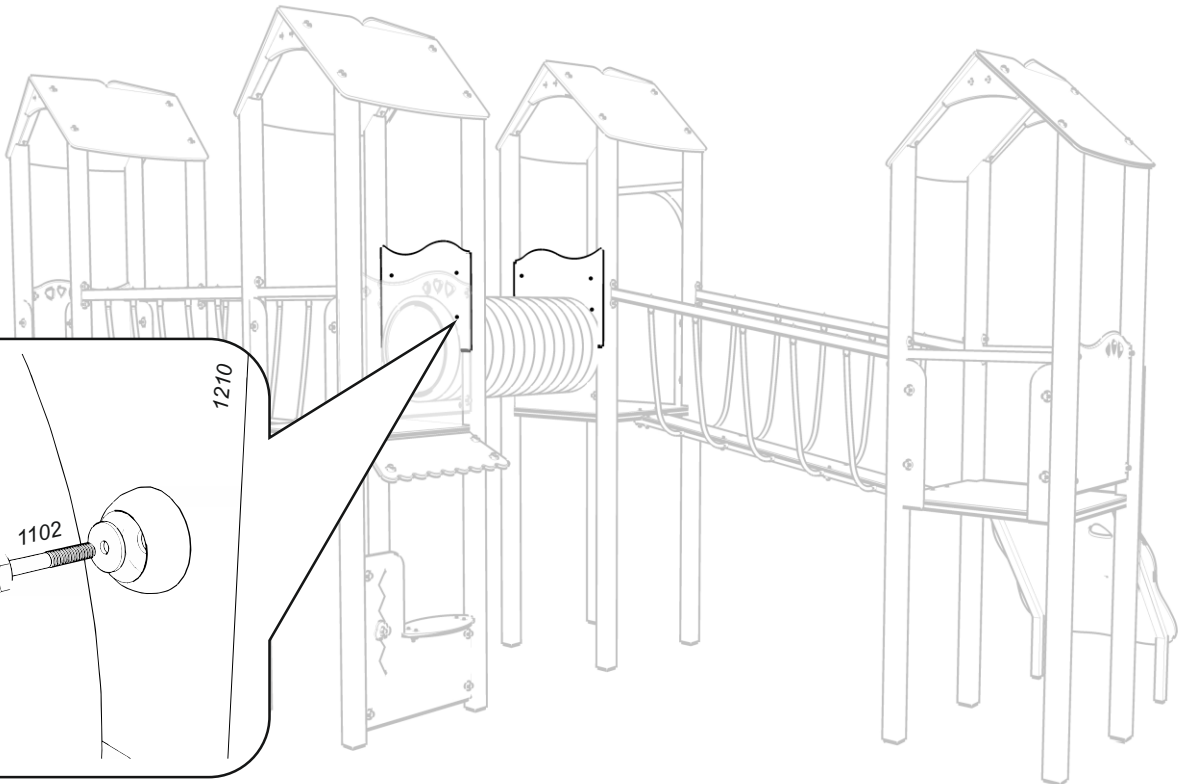
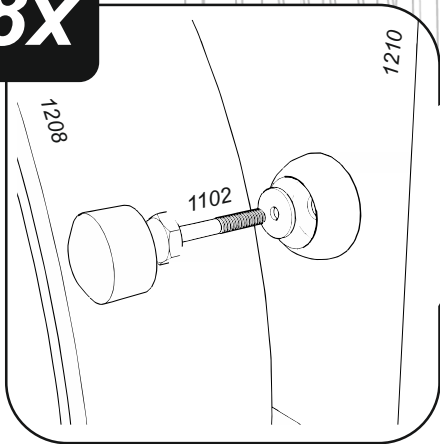

11



17



3x

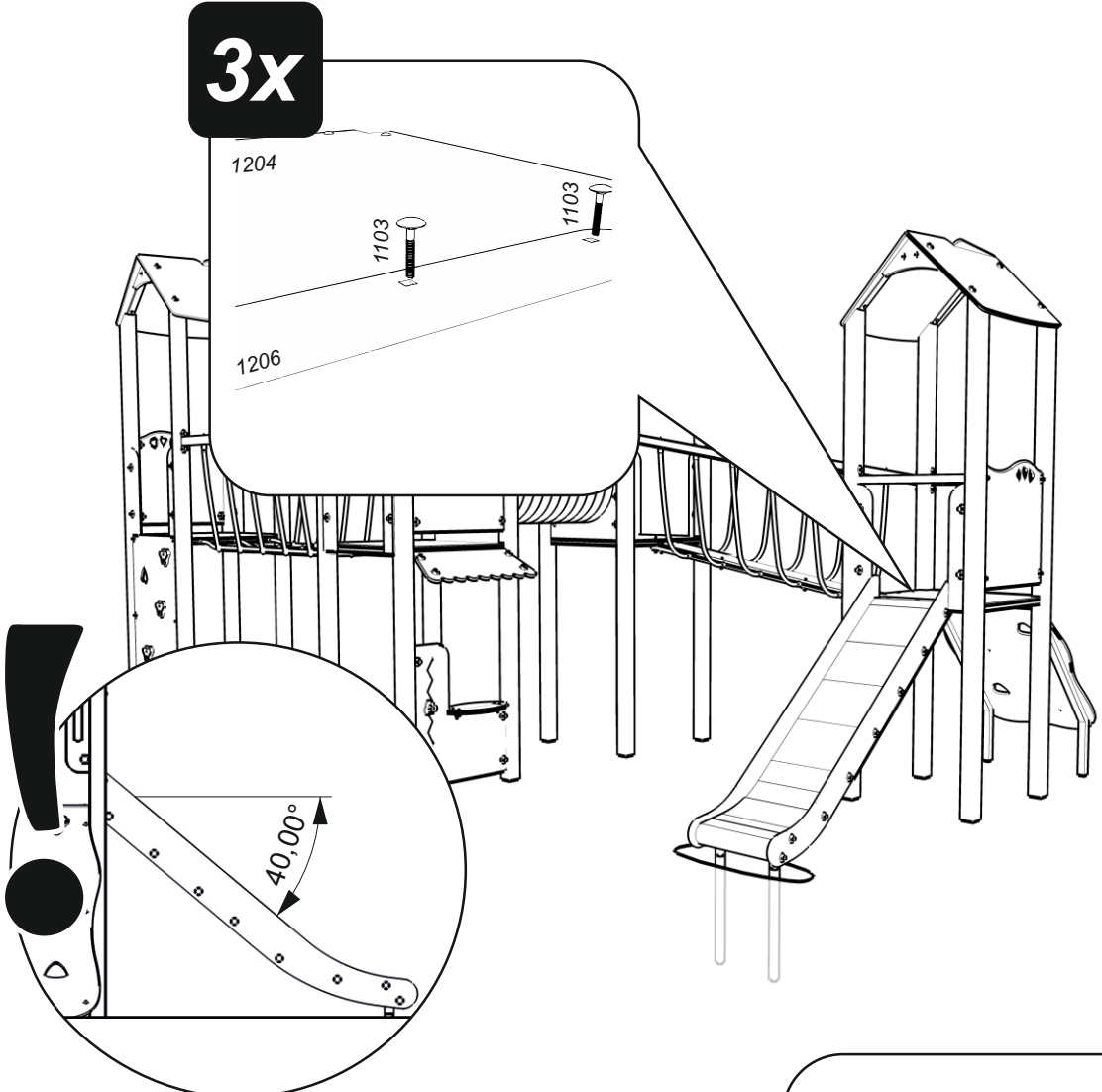

12







17

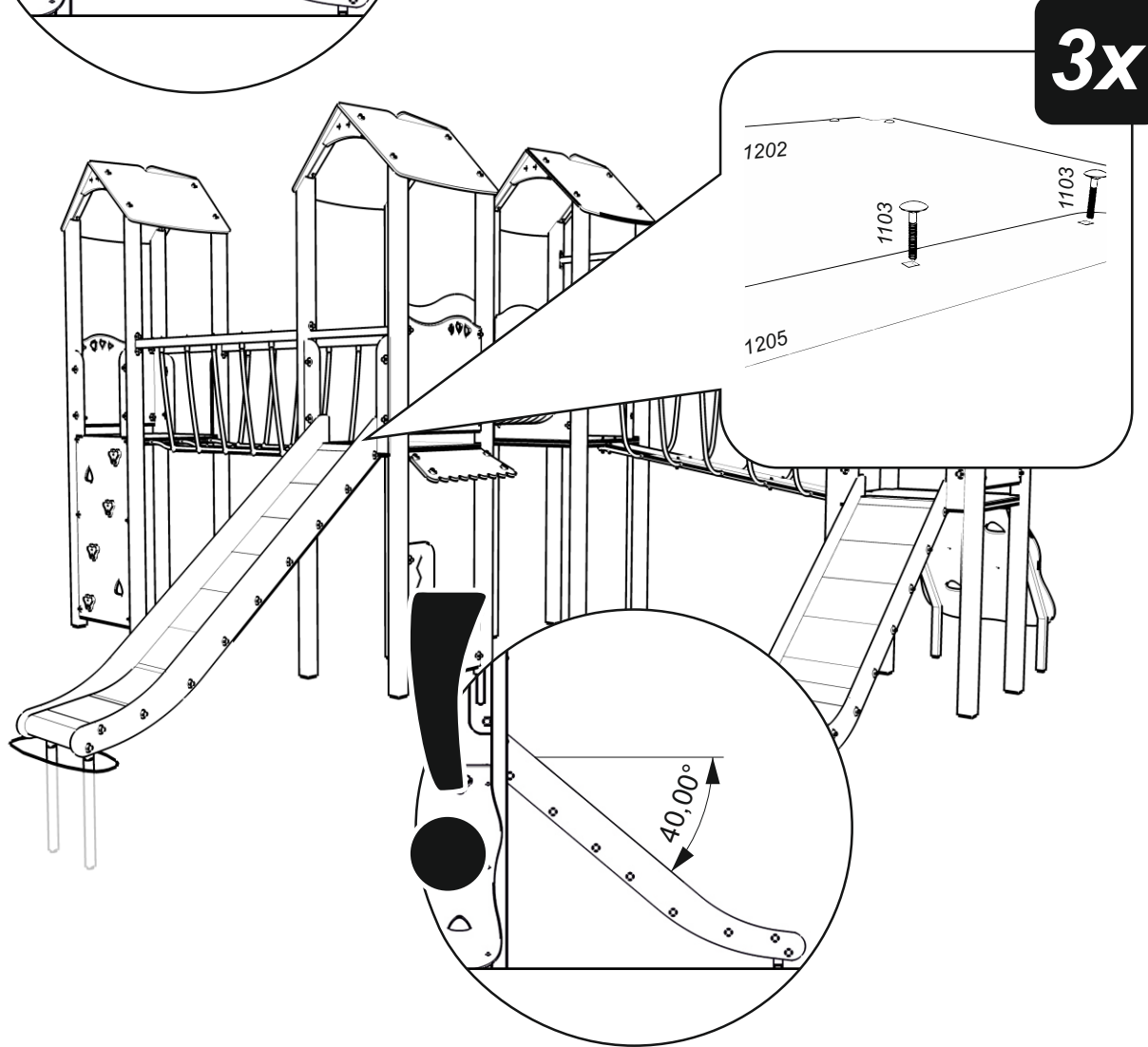

3x

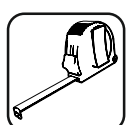

13

- 
- 
- 
- 
- 17

- 