

INSTRUKCJA MONTAŻU INSTALLATION INSTRUCTIONS

nr kat. 0200
art. N° 0200

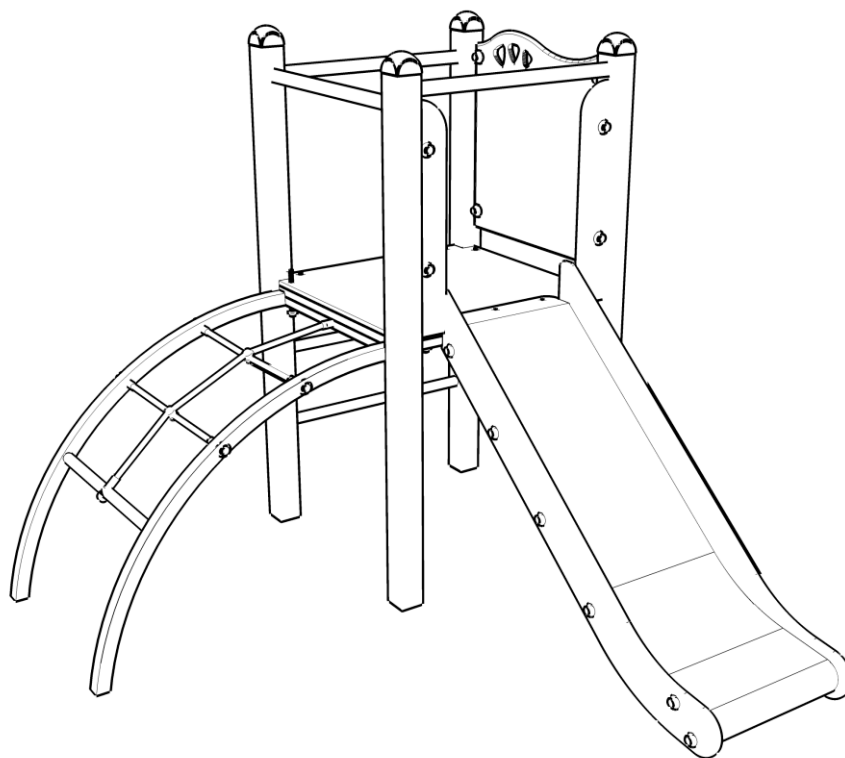

STREFA BEZPIECZEŃSTWA safety zone

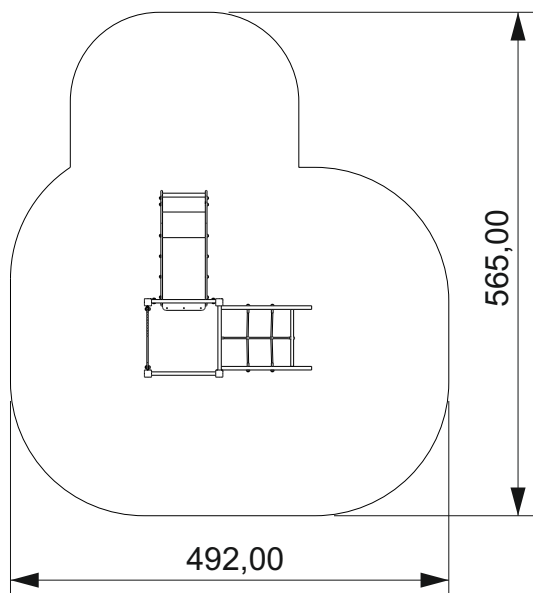

WYMIARY URZĄDZENIA dimensions

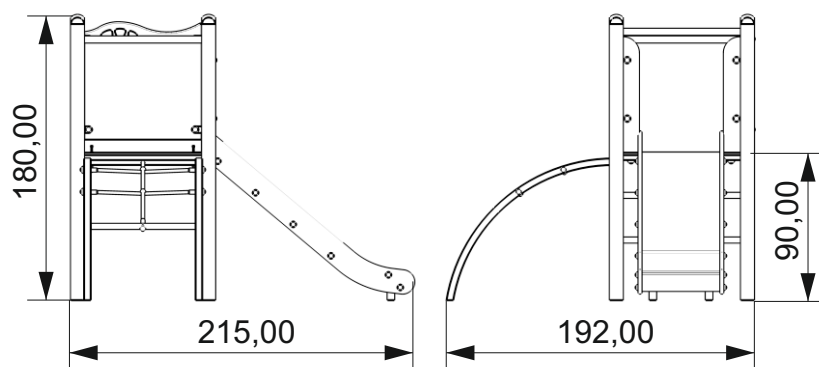

NARZĘDZIA tools

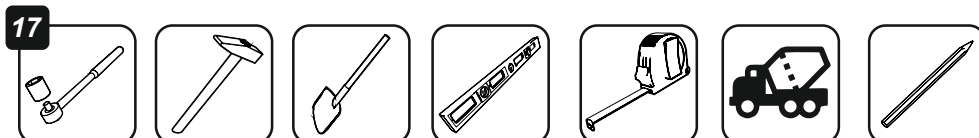

FUNDAMENTY

basement

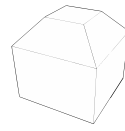
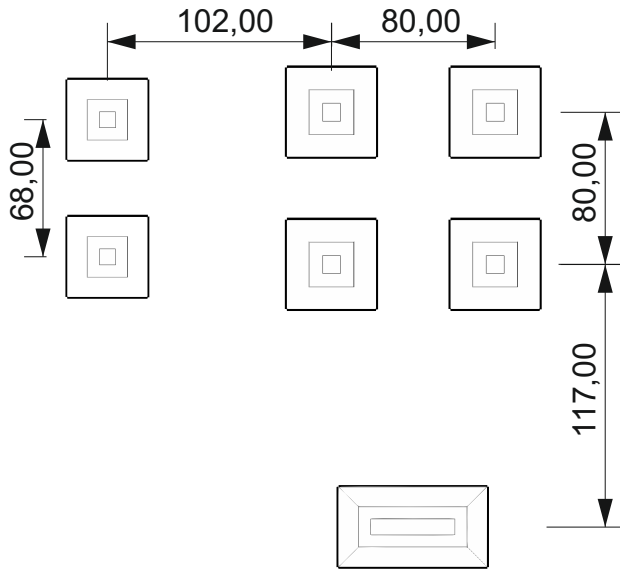
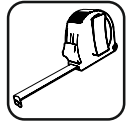

7x

0,06 m³



48h

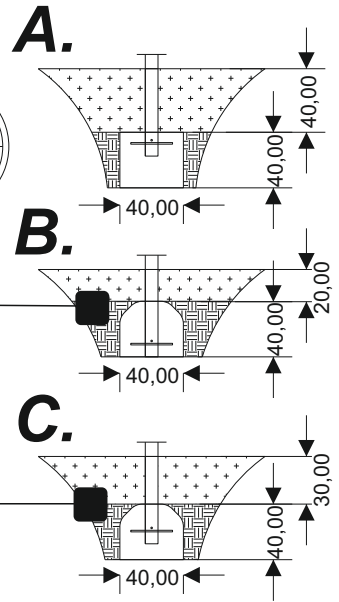

ELEMENTY SKŁADOWE

components



2x

1101 M10x95



3x

1102 M10x35

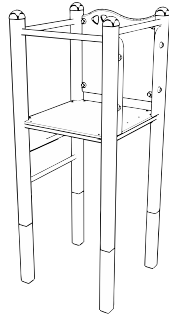

1x

1201

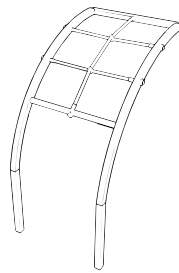

1x

1202

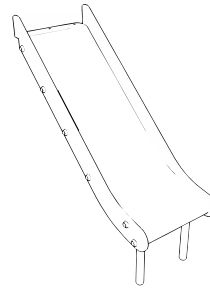



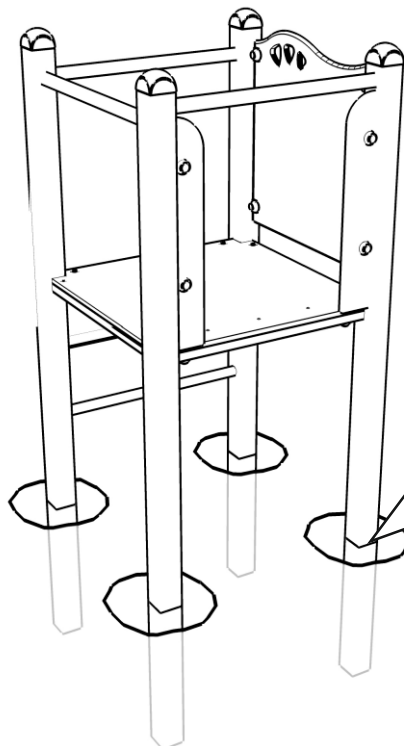

1x

1203

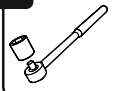

2

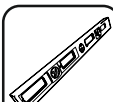
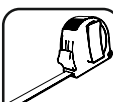
2x

- 17 
- 
- 
- 
- 
- 

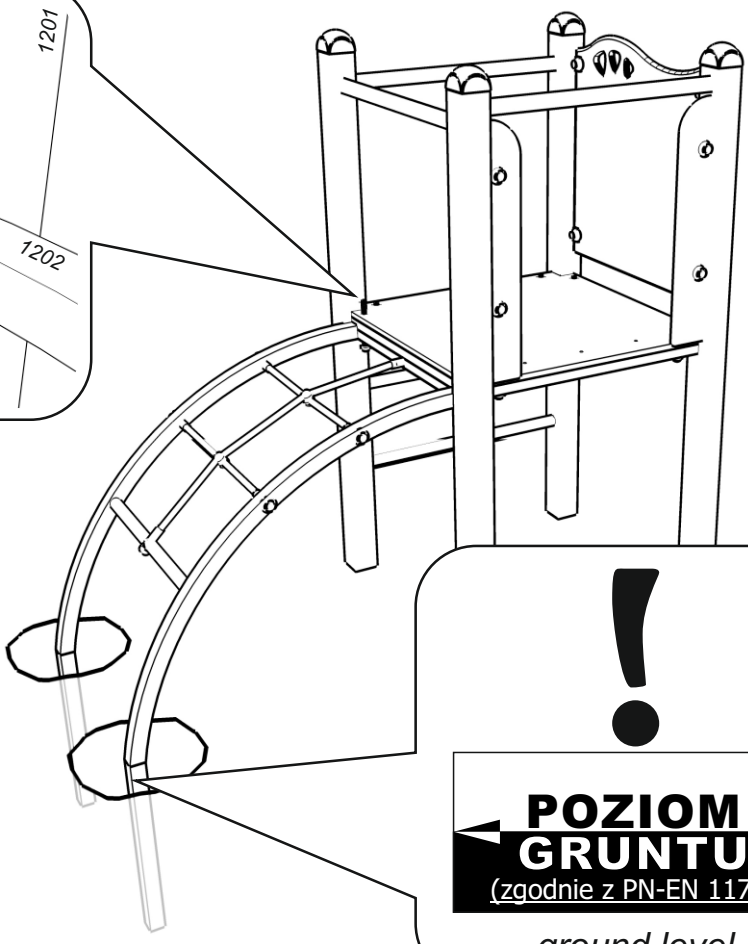
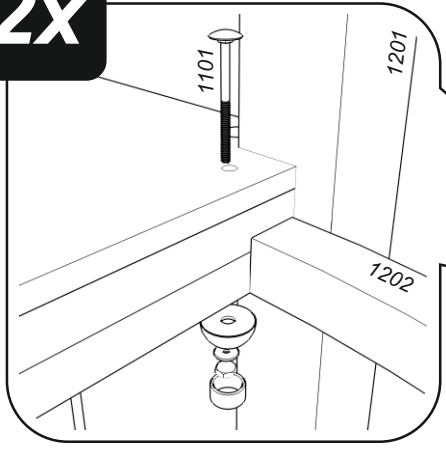

!





**POZIOM
GRUNTU**

(zgodnie z PN-EN 1177)

ground level

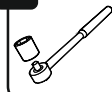
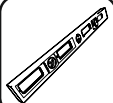
3

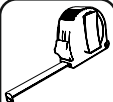
3x

- 17 
- 
- 
- 
- 
- 