

INSTRUKCJA MONTAŻU INSTALLATION INSTRUCTIONS

nr kat. 0605a; 0605b; 0606; 0607; 0608; 0609
art. N° 0605a; 0605b; 0606; 0607; 0608; 0609

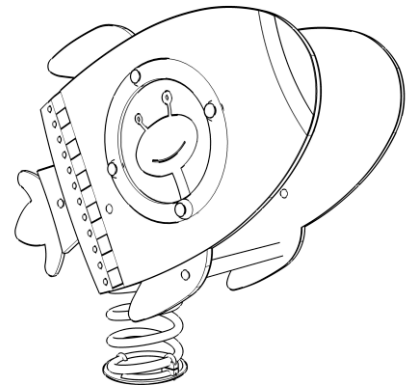

STREFA BEZPIECZEŃSTWA safety zone

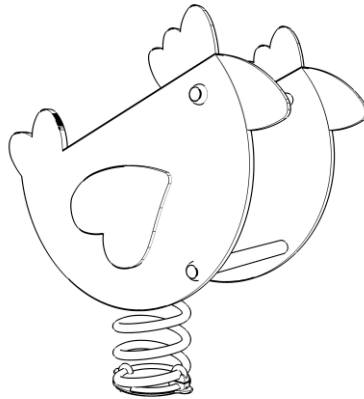
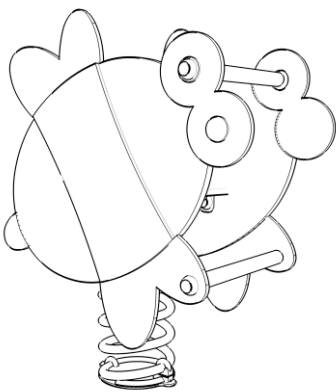
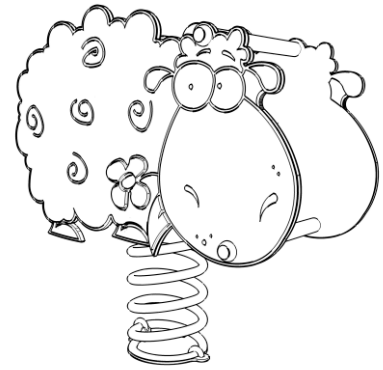
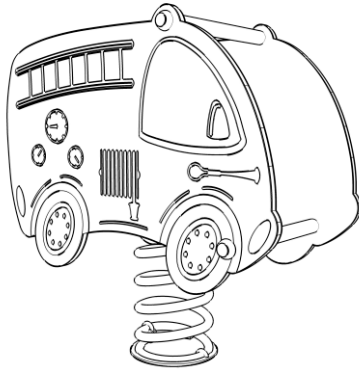
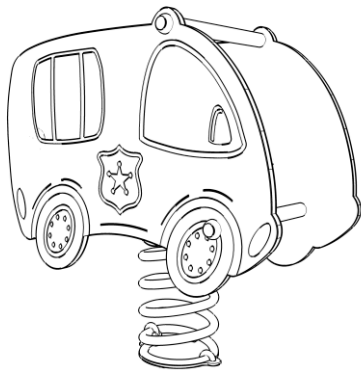
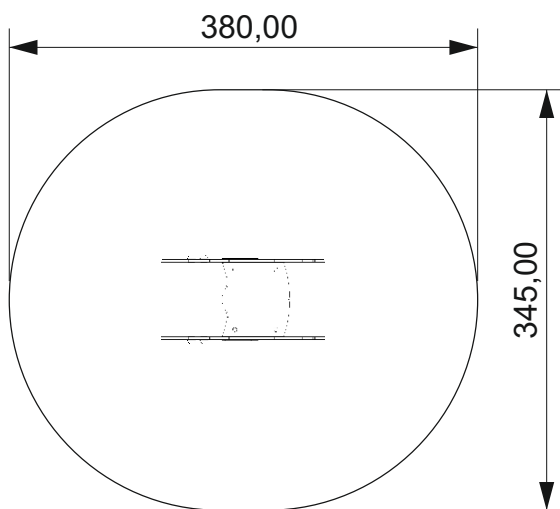

WYMIARY URZĄDZENIA dimensions

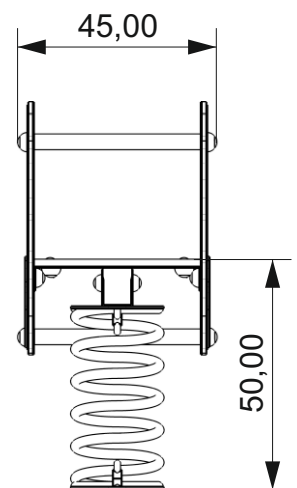
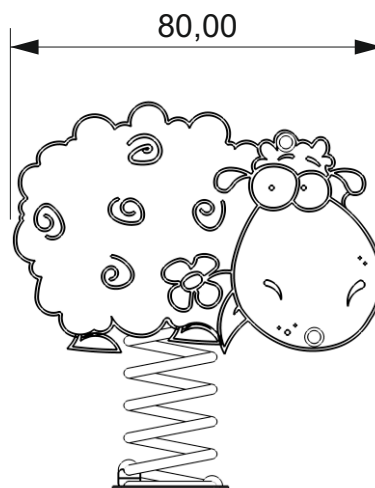

NARZĘDZIA tools

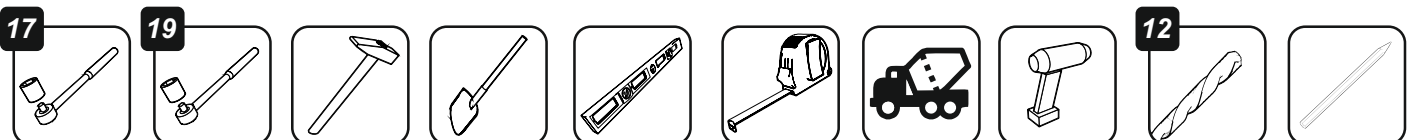

ELEMENTY SKŁADOWE
components

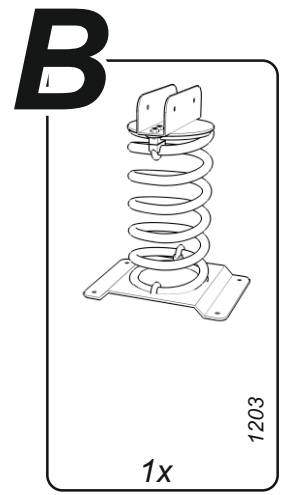
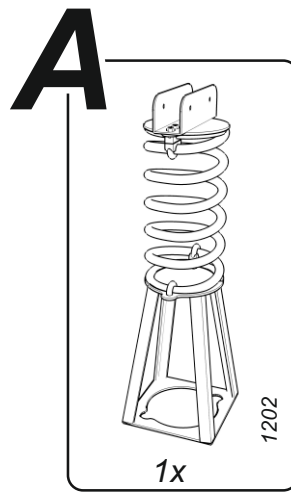
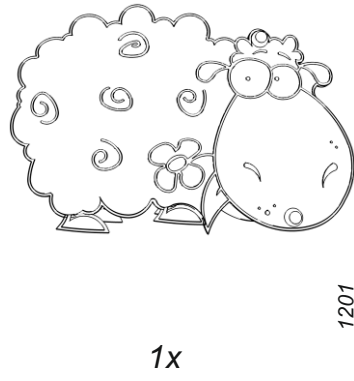
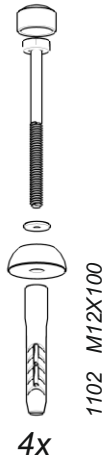
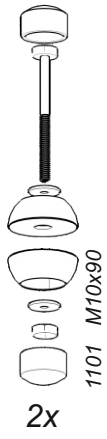

A

1

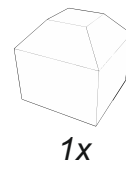
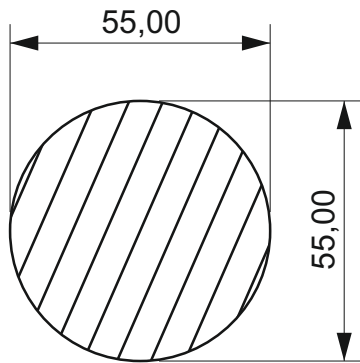

0,032 m³

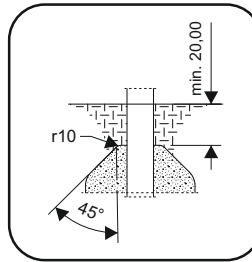
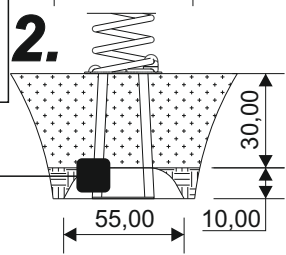
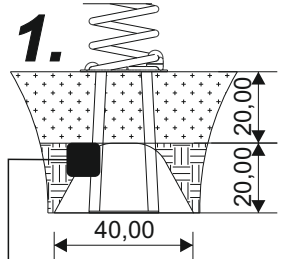

2

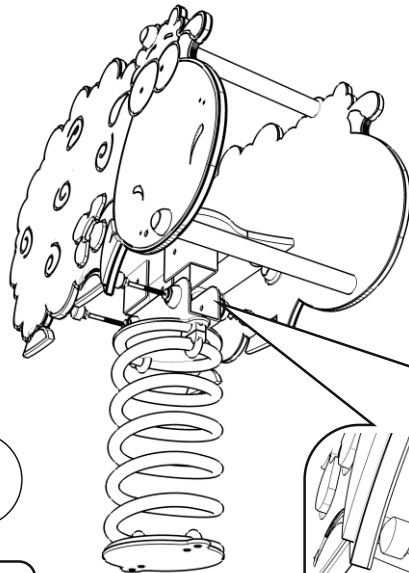
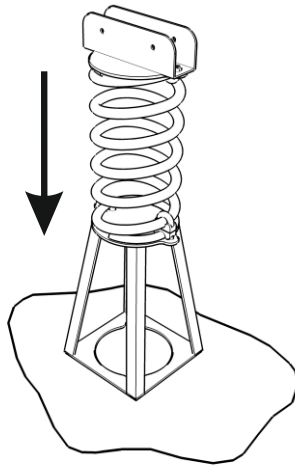

3

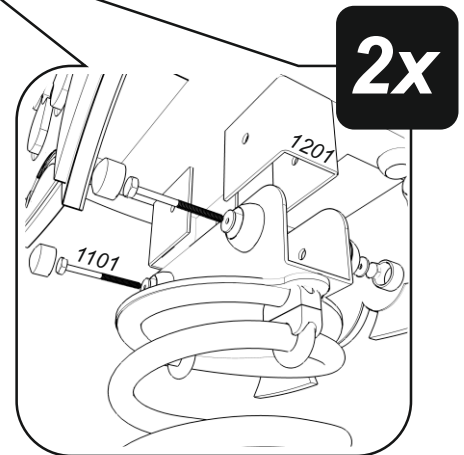

B

1

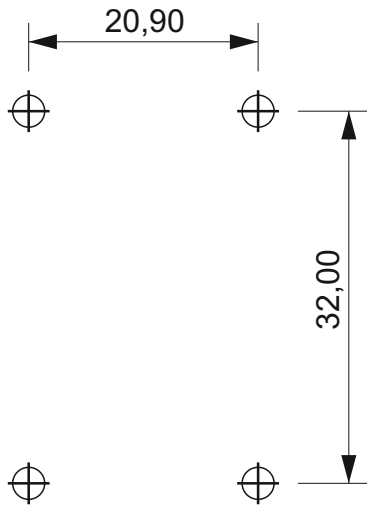

2

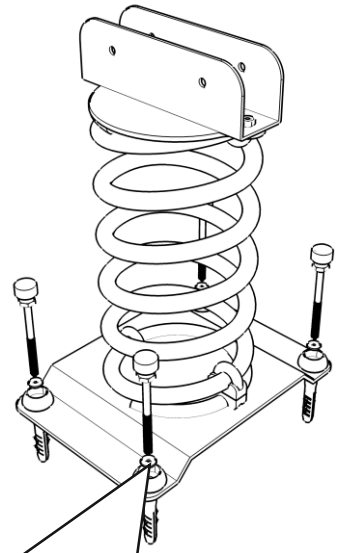
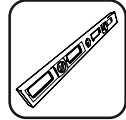

4x

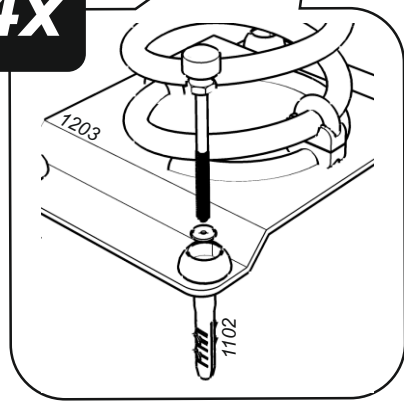

3

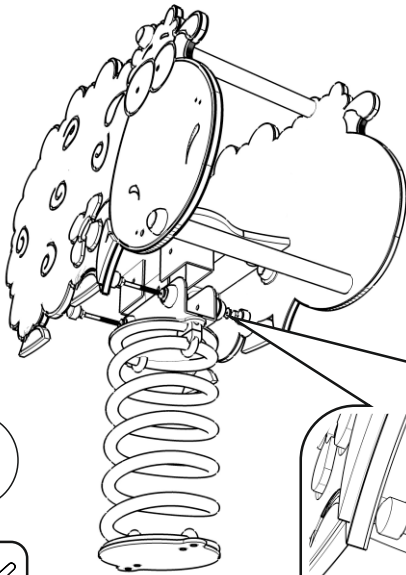

2x

