

INSTRUKCJA MONTAŻU INSTALLATION INSTRUCTIONS

nr kat. 0601
art. N° 0601

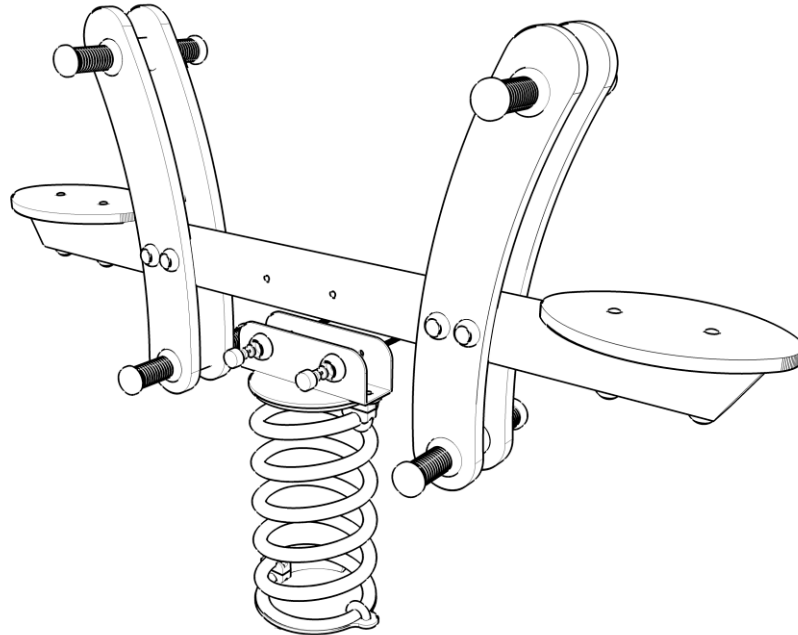

STREFA BEZPIECZEŃSTWA safety zone

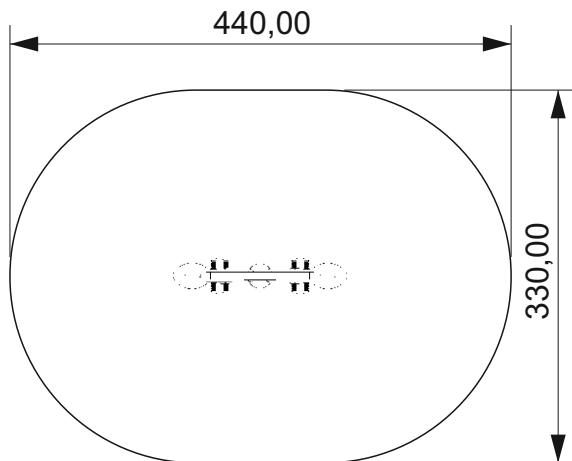

WYMIARY URZĄDZENIA dimensions

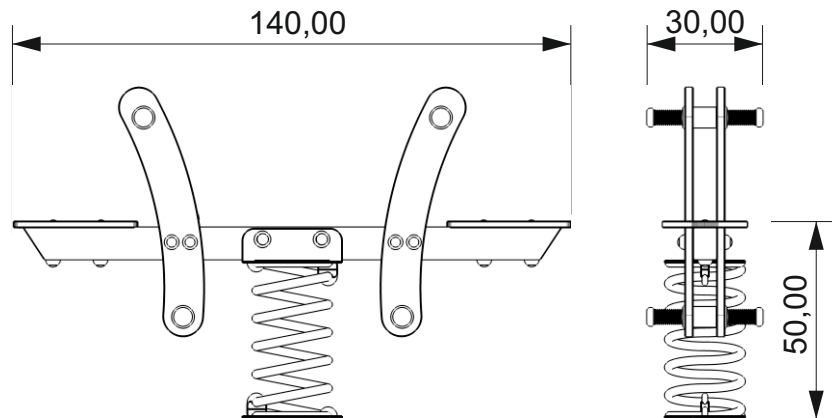

NARZĘDZIA tools

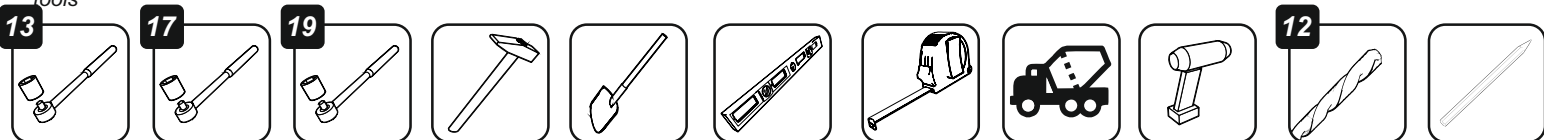

ELEMENTY SKŁADOWE
components

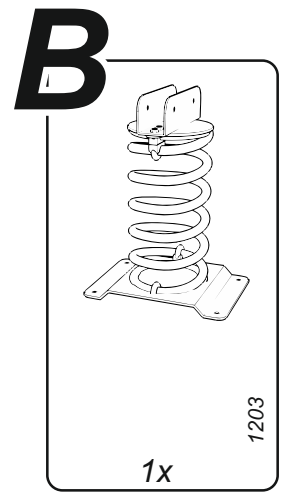
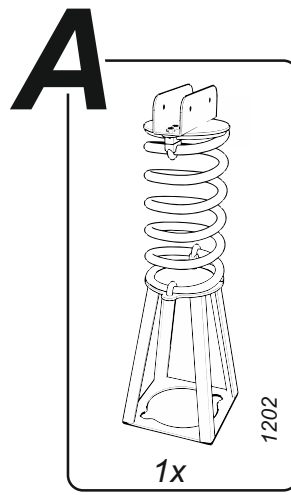
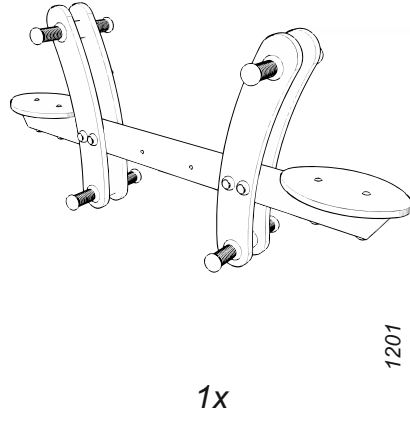
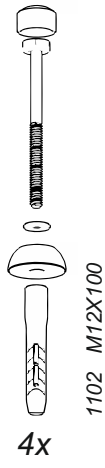
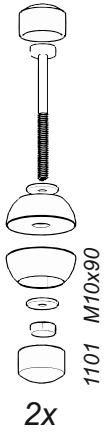

A

1

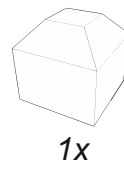
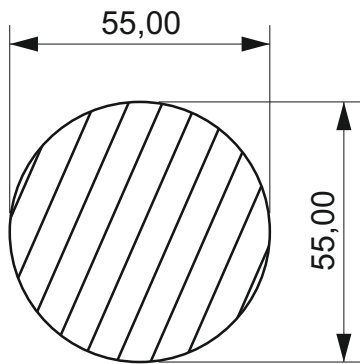
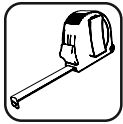

0,032 m³

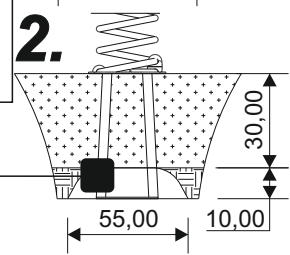
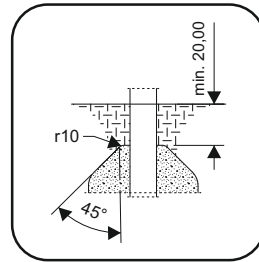
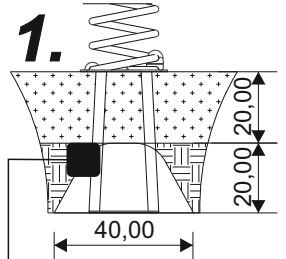

2

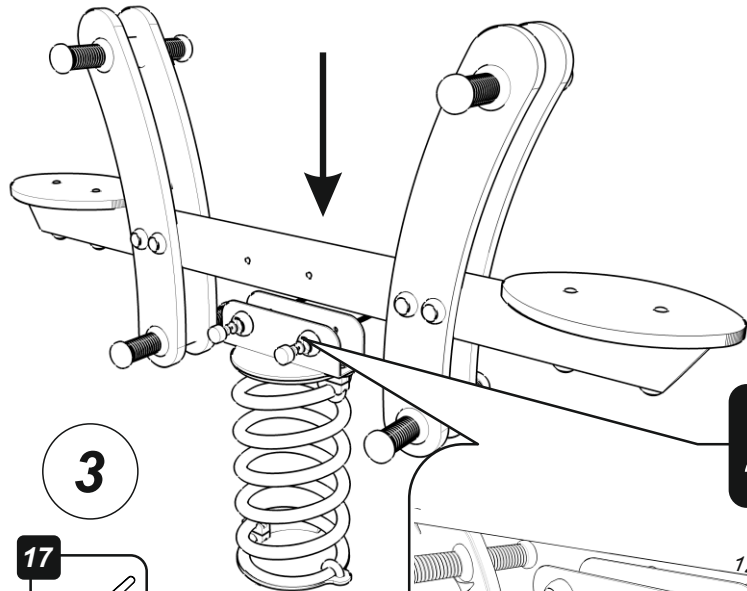
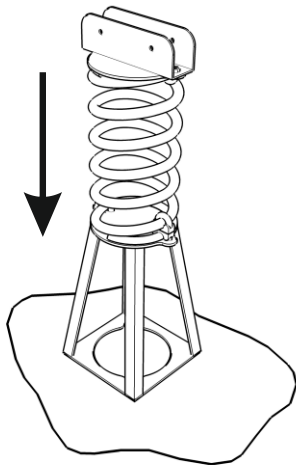
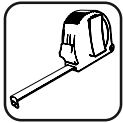

3



2x

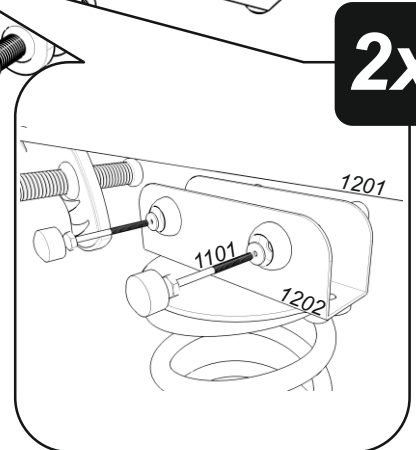

B

1

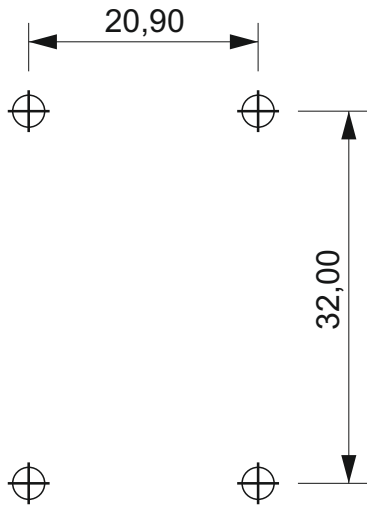

2

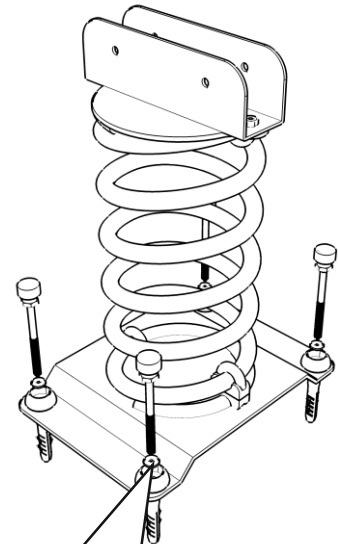
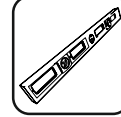
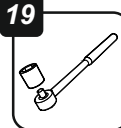

4x

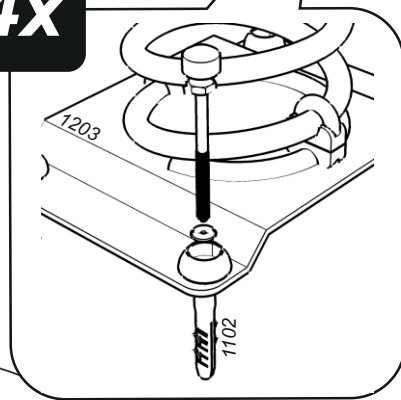

3

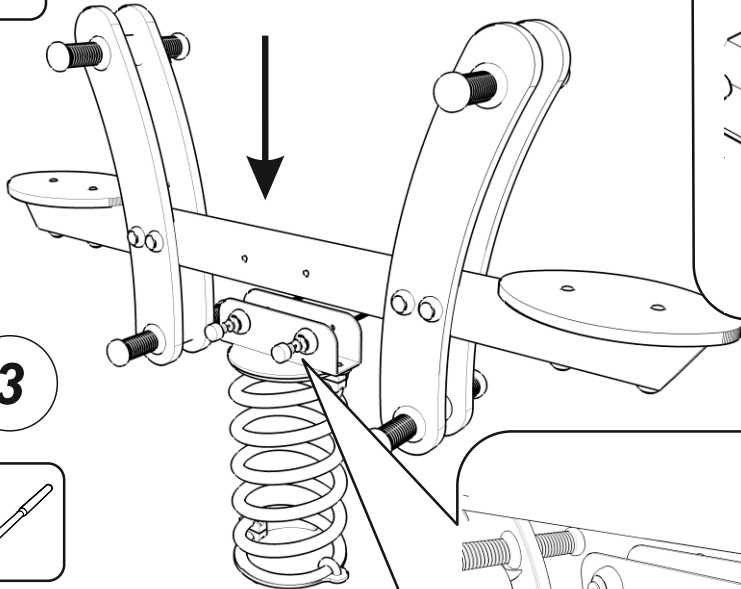

2x

