

## INSTRUKCJA MONTAŻU INSTALLATION INSTRUCTIONS

nr kat. 0802  
art. N° 0802

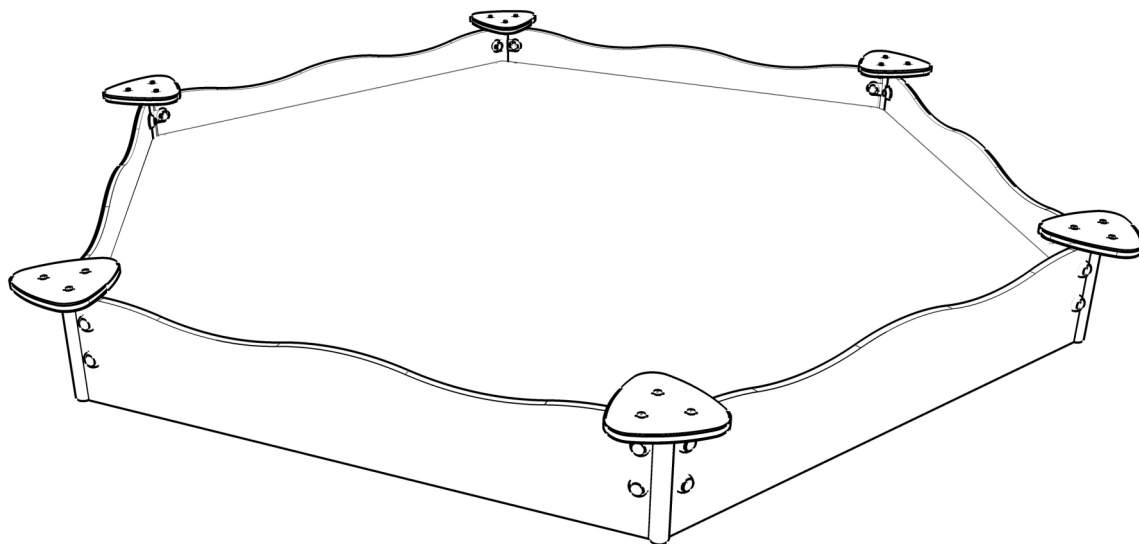

### STREFA BEZPIECZEŃSTWA

safety zone

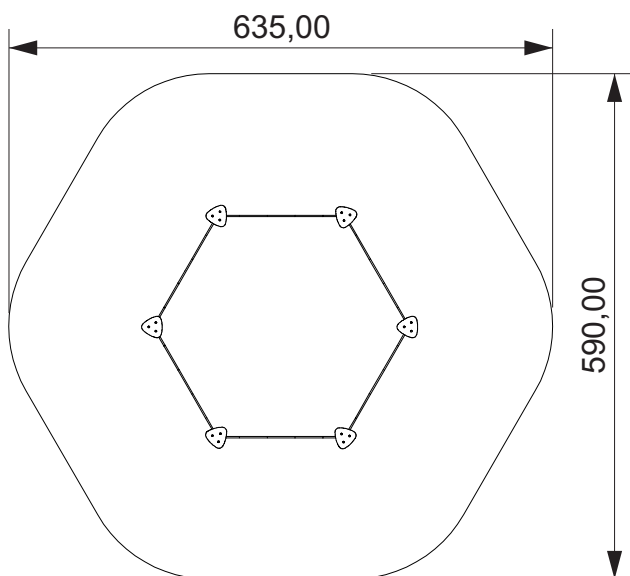

### WYMIARY URZĄDZENIA

dimensions

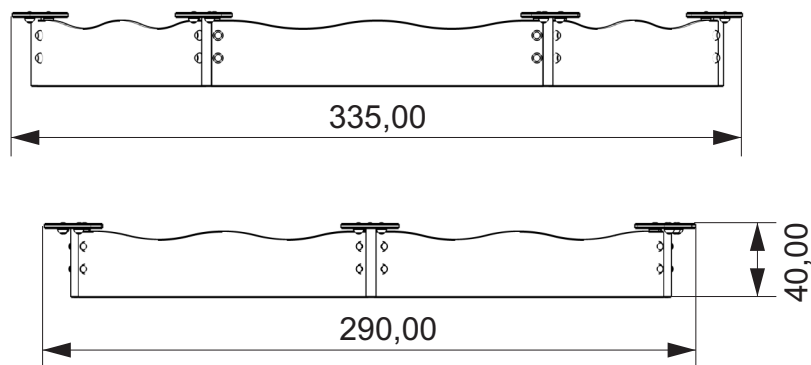

### NARZĘDZIA

tools

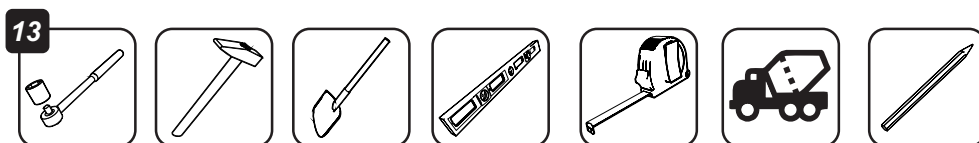

13

# FUNDAMENTY

basement

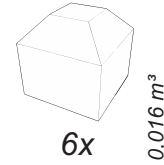
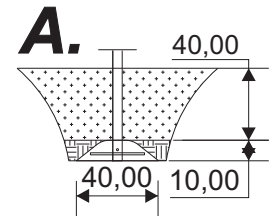
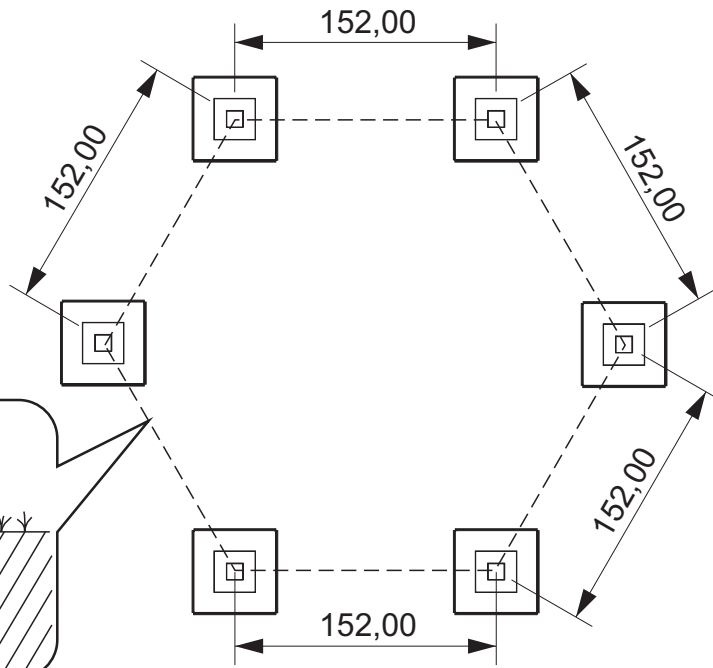
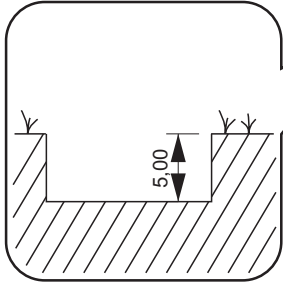
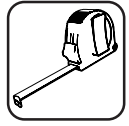

0,016 m<sup>3</sup>



# ELEMENTY SKŁADOWE

components

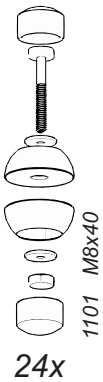

24x

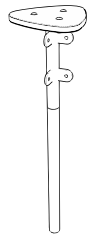

6x

1201

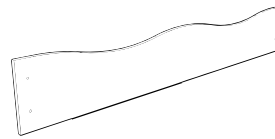

6x

1202

1

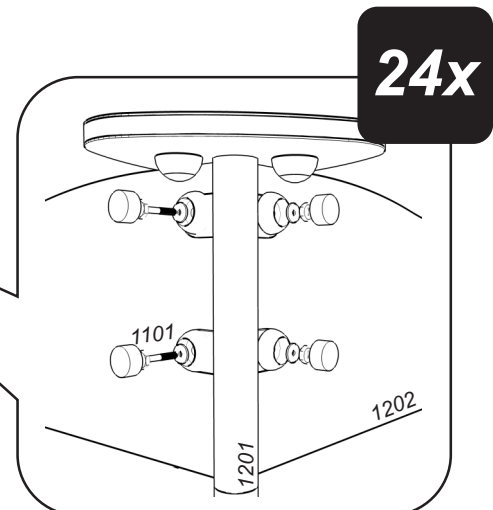
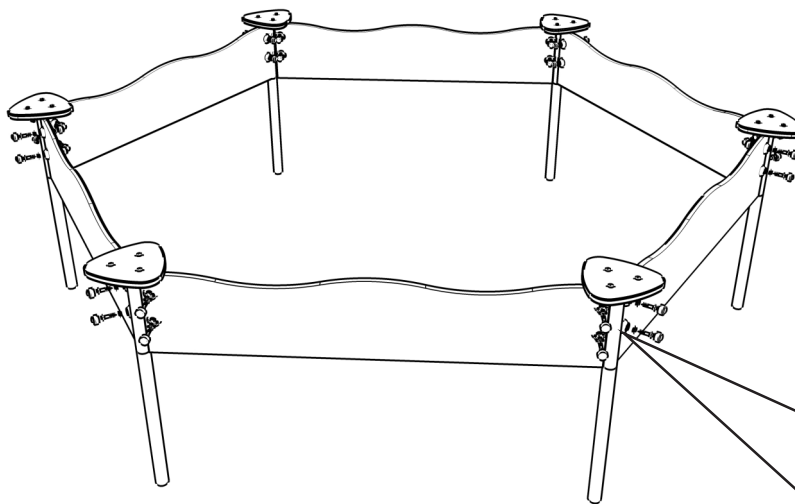
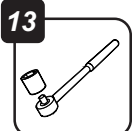

2

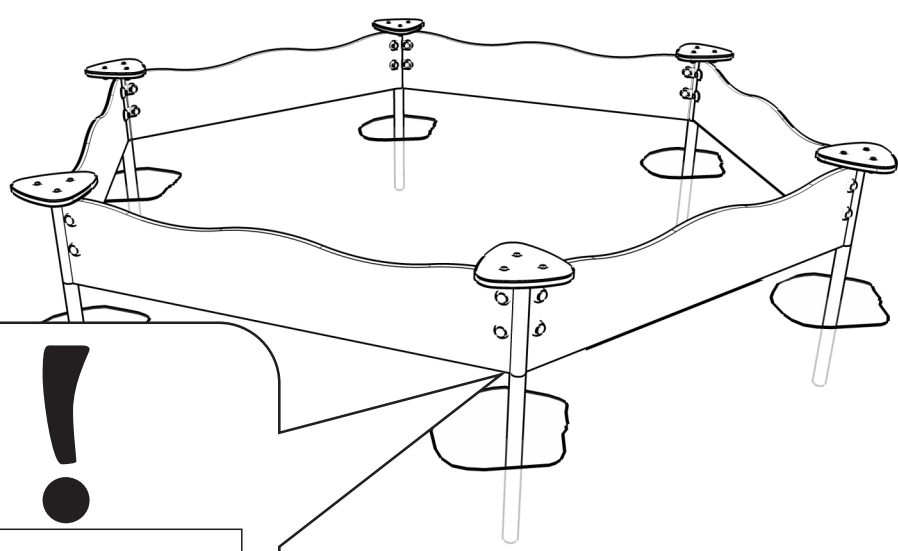

**!**

**POZIOM  
GRUNTU**  
(zgodnie z PN-EN 1177)

*ground level*

3

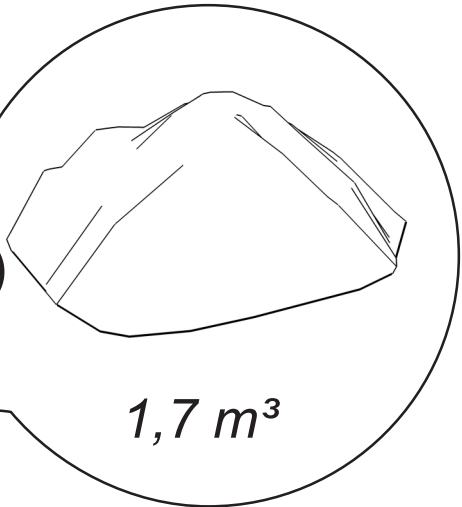

1,7 m<sup>3</sup>

