

INSTRUKCJA MONTAŻU INSTALLATION INSTRUCTIONS

nr kat. 0419
art. N° 0419

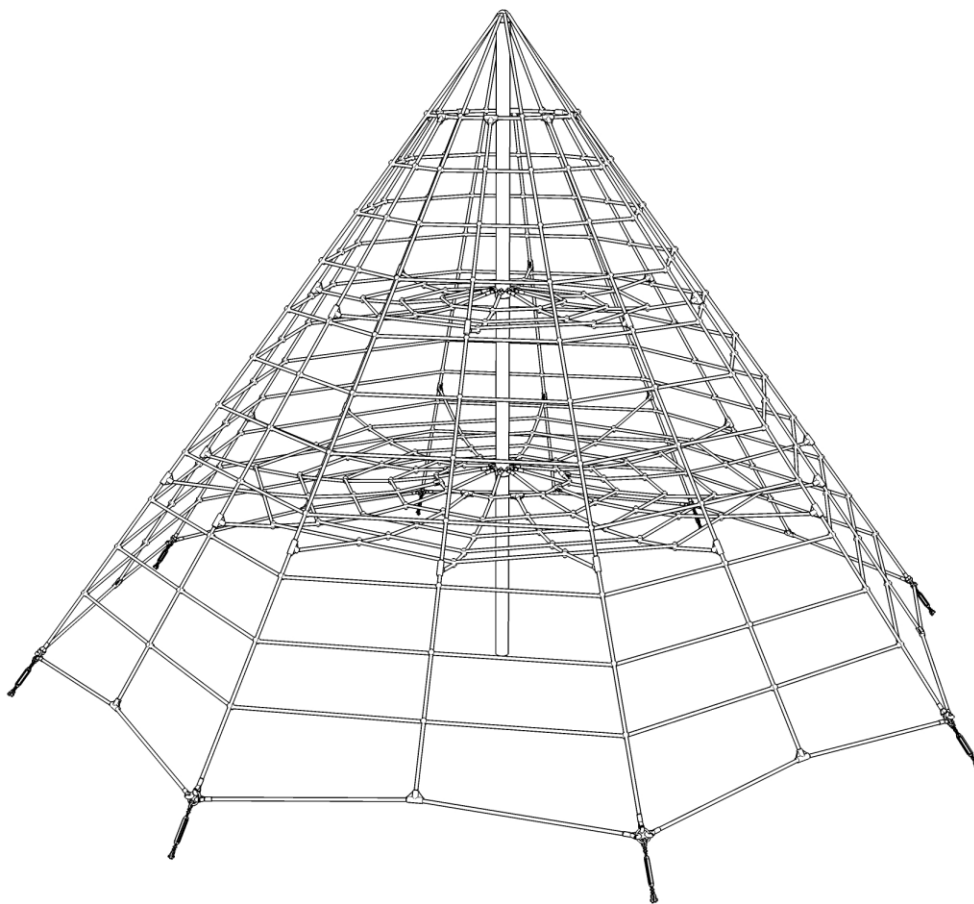

STREFA BEZPIECZEŃSTWA safety zone

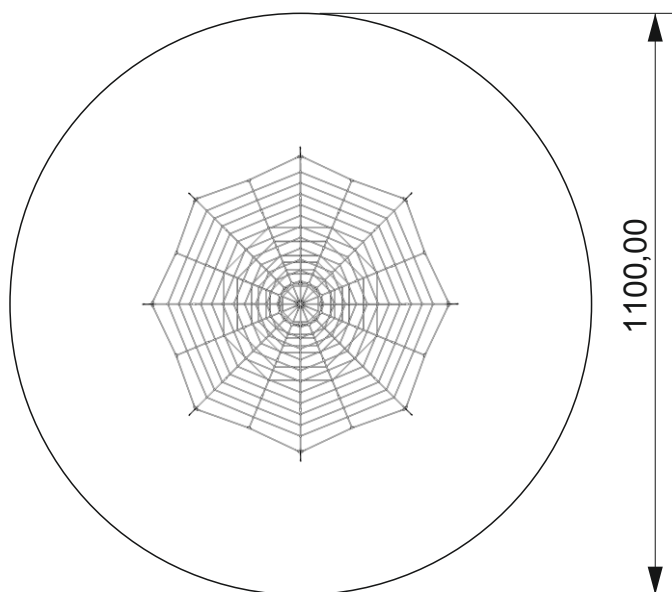

WYMIARY URZĄDZENIA dimensions

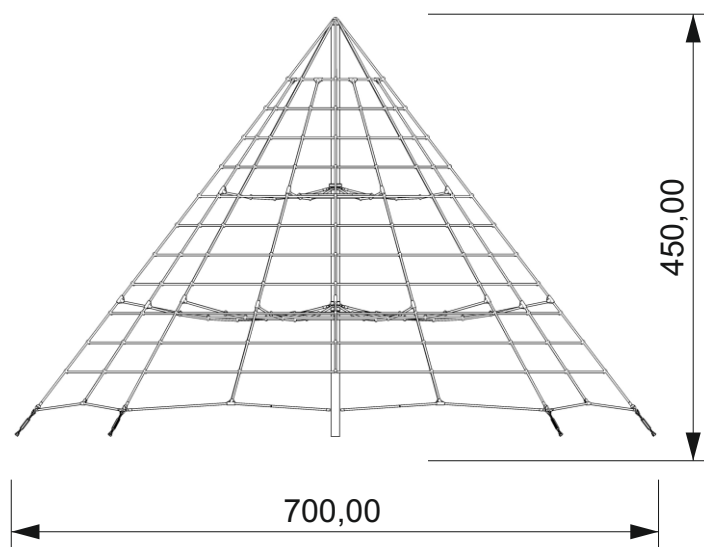

NARZĘDZIA tools

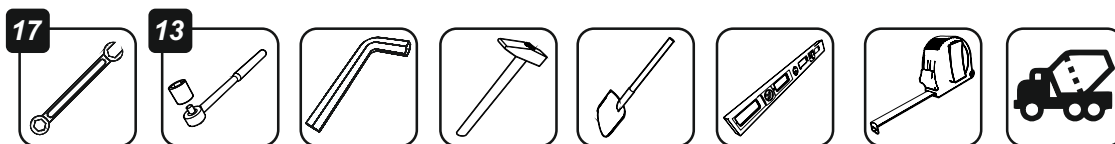

FUNDAMENTY

basement

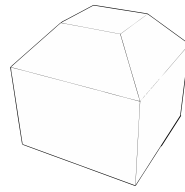

1x

80x80x50cm - 0,144 m³

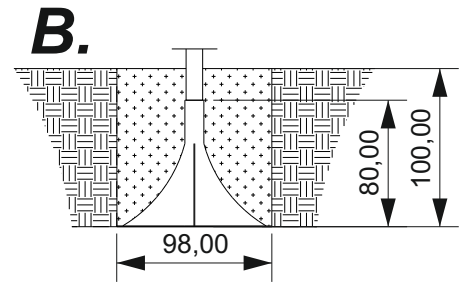
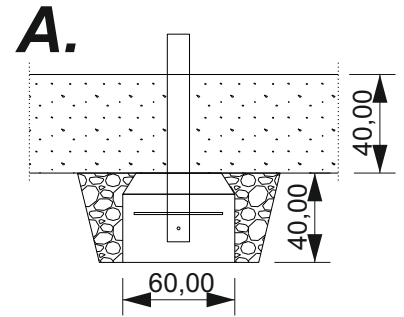
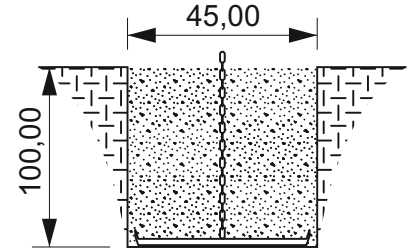
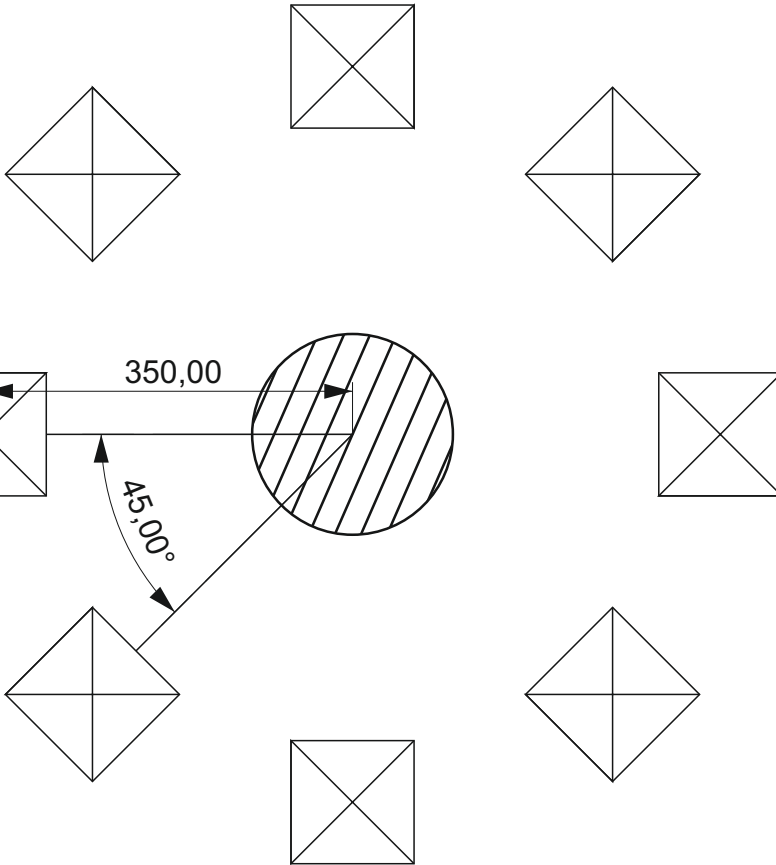

ELEMENTY SKŁADOWE

components

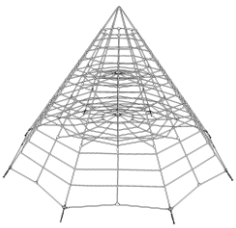

1x

1201



1x

1202



8x

1203

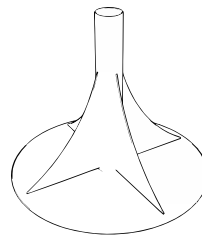

1x

1204

A

1



!
**POZIOM
GRUNTU**
(zgodnie z PN-EN 1177)
ground level

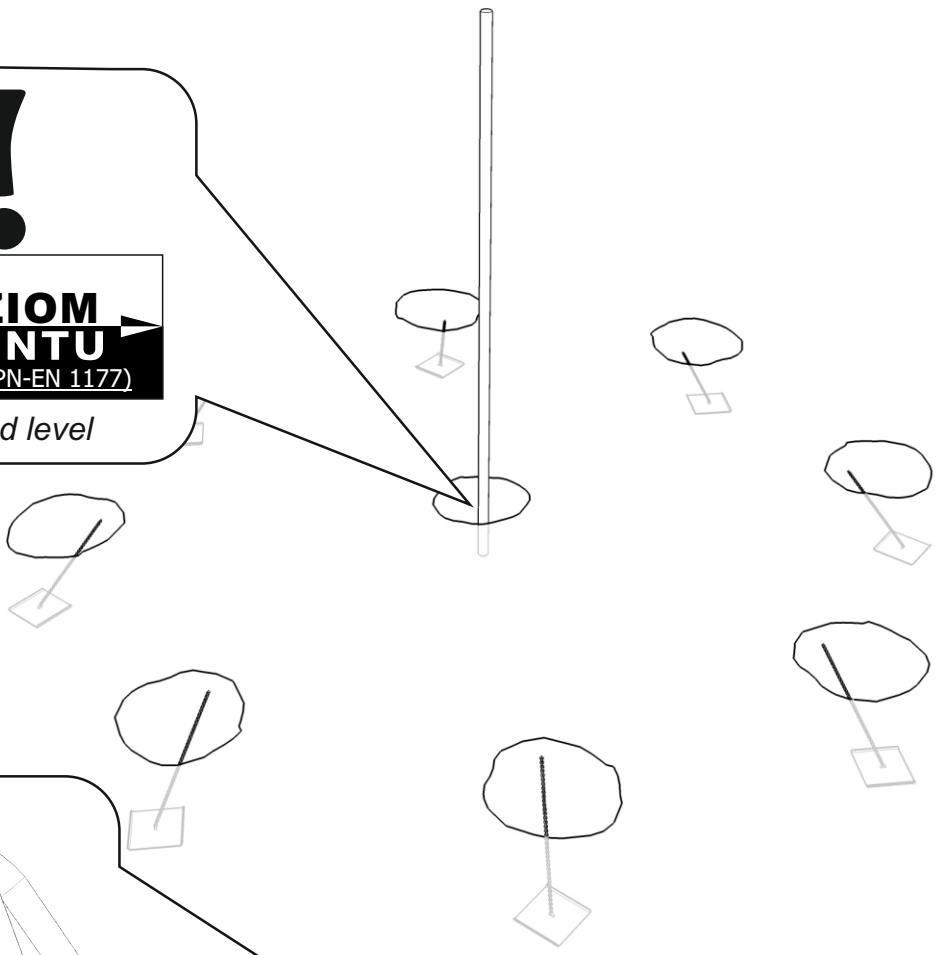

2

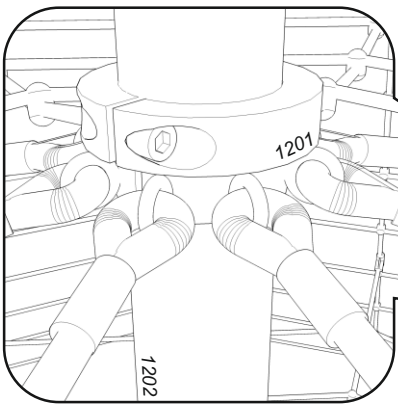
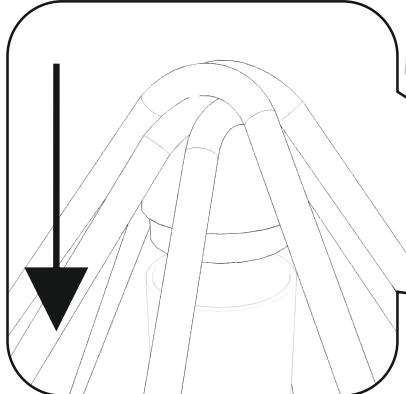

13



8x

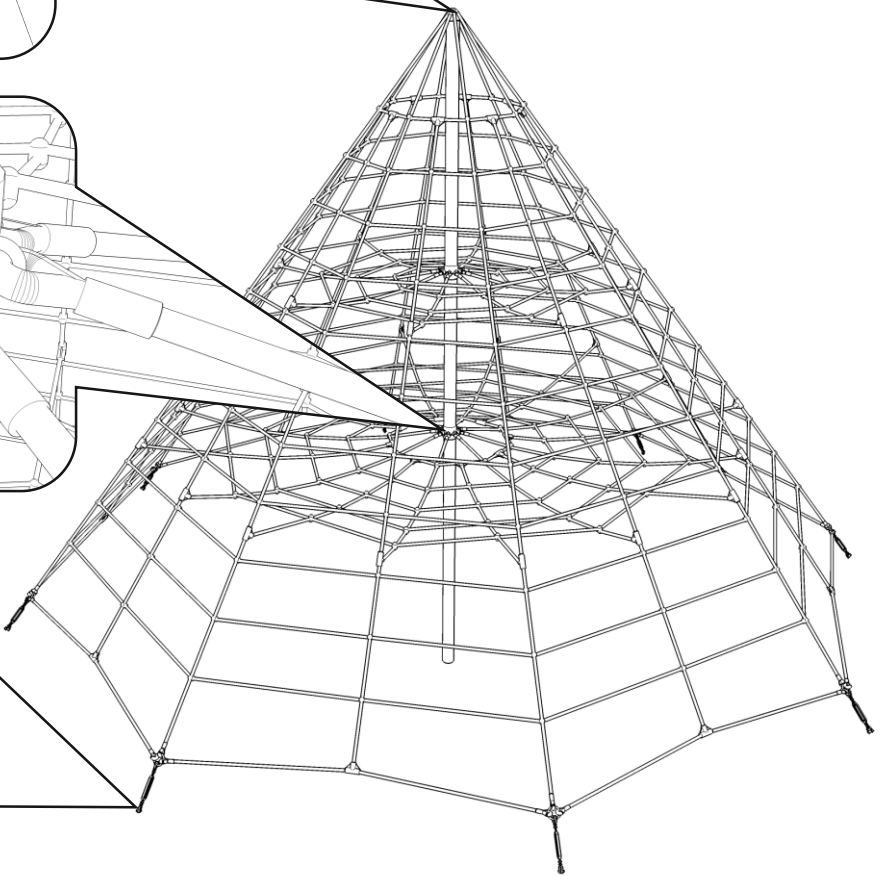
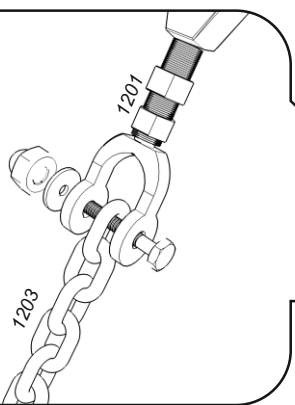

A

3

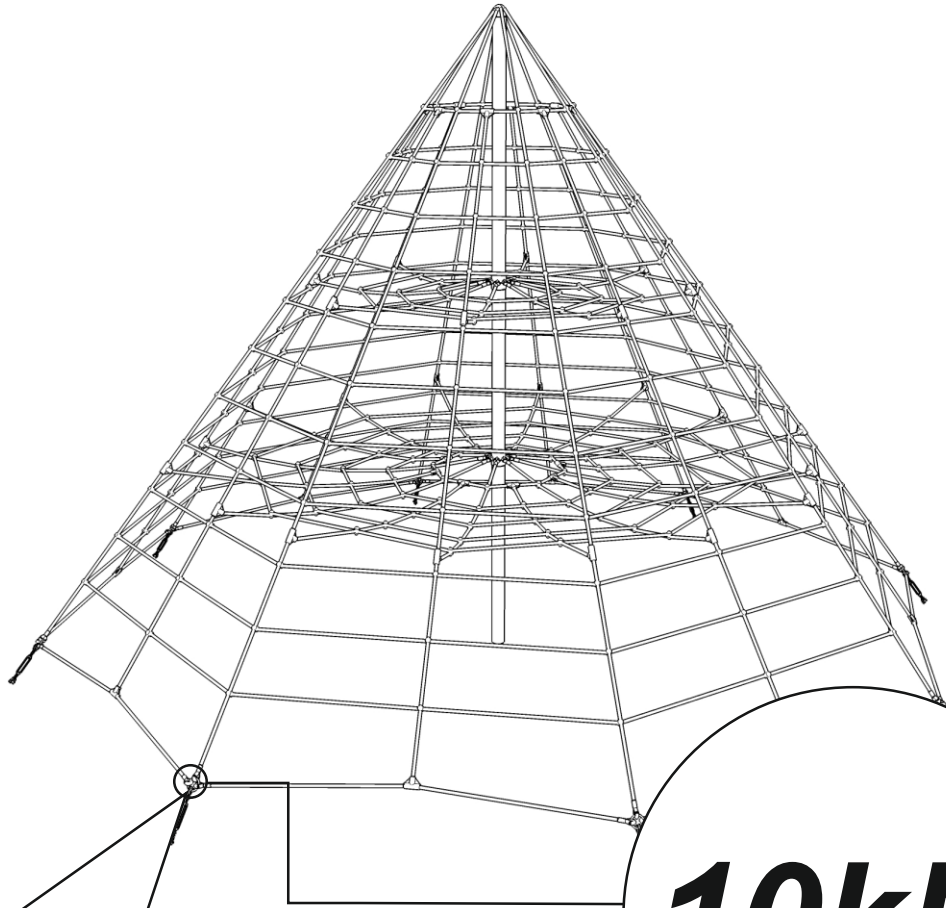

10kN!

8x

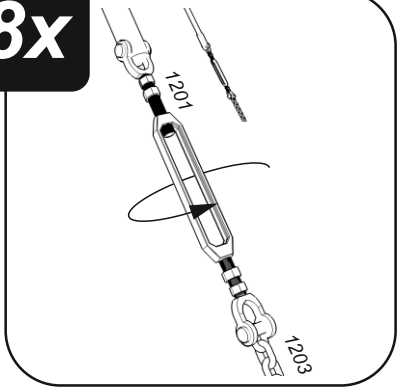

B

1

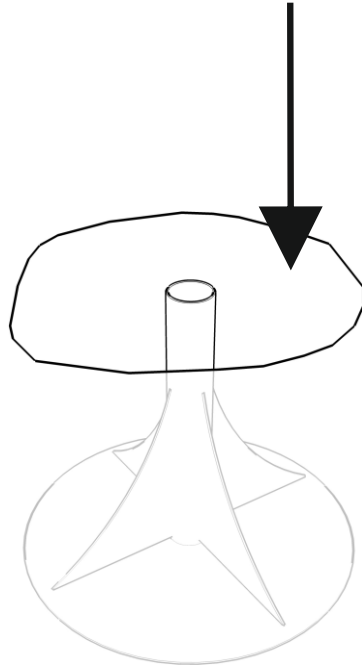

2

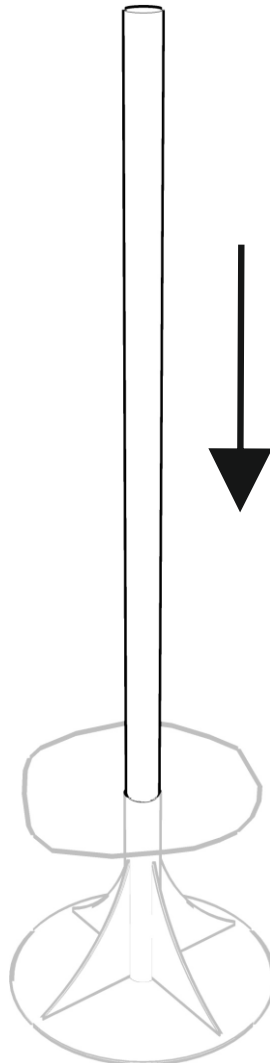

B

3

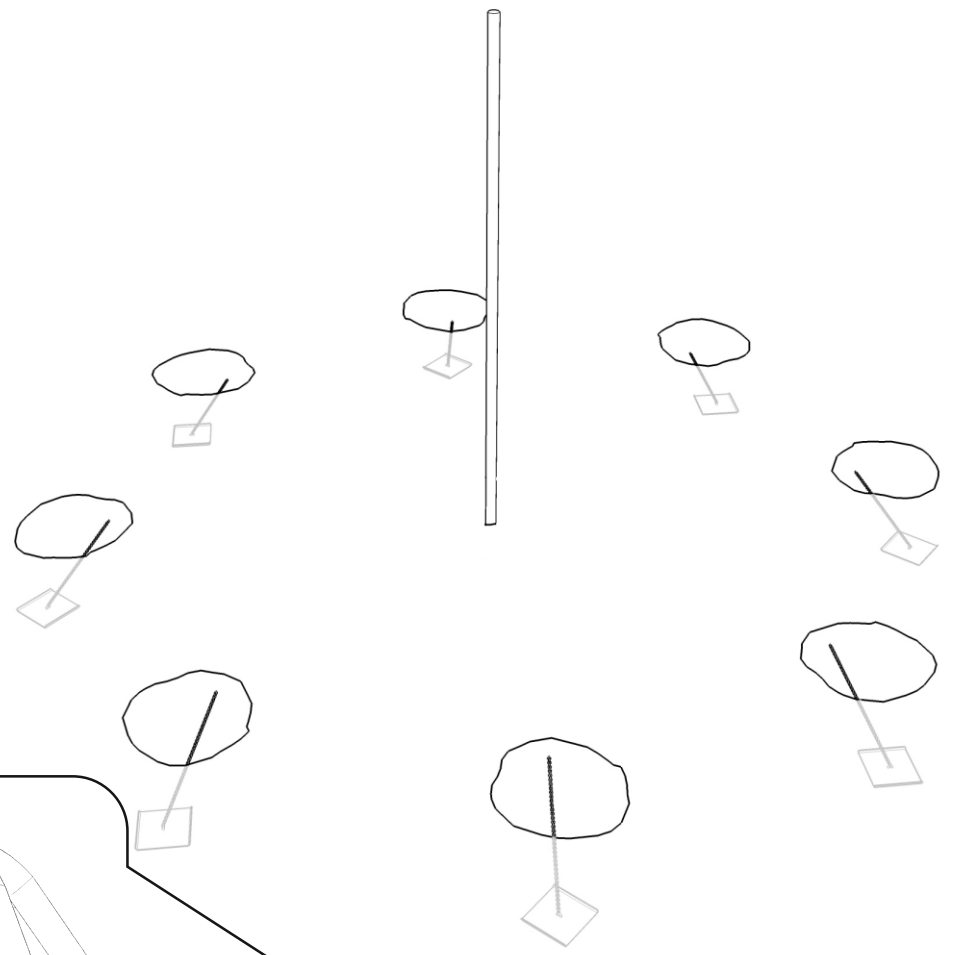

4



13

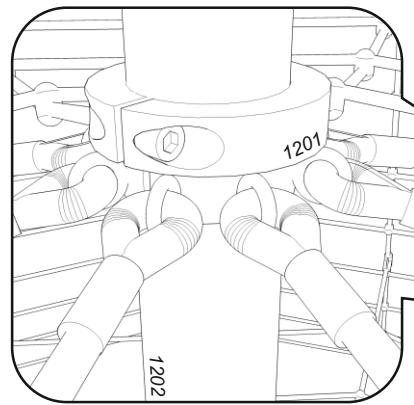
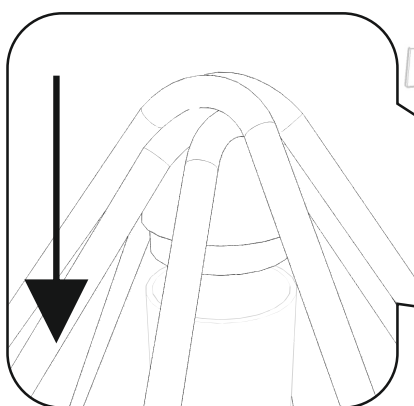

8x

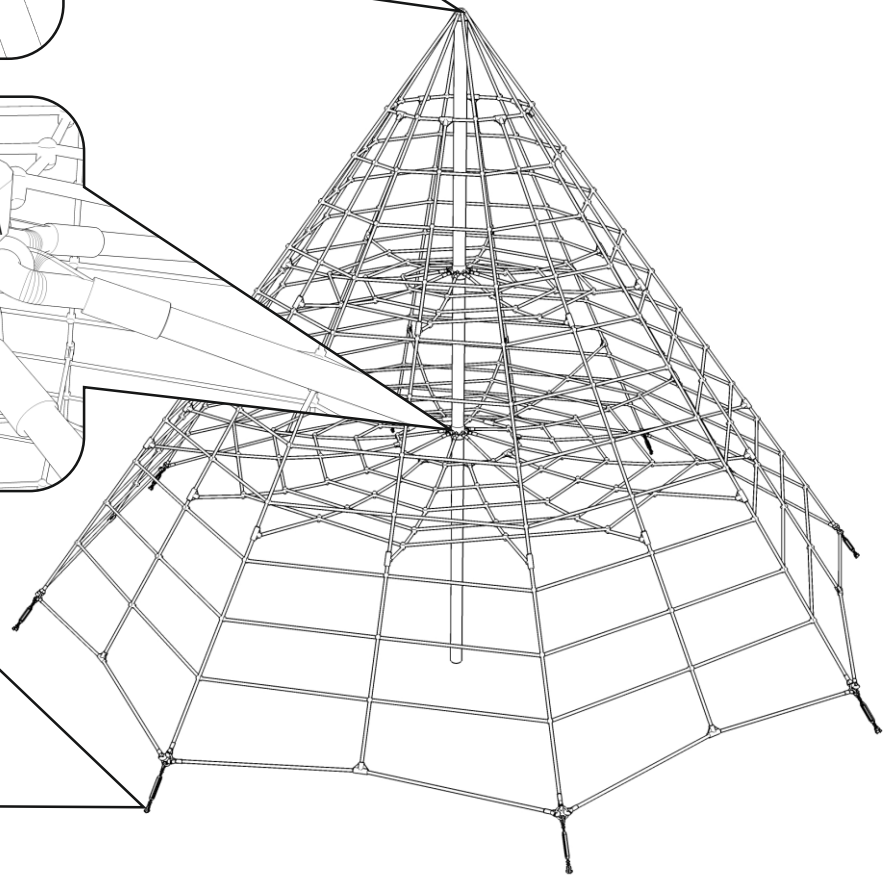
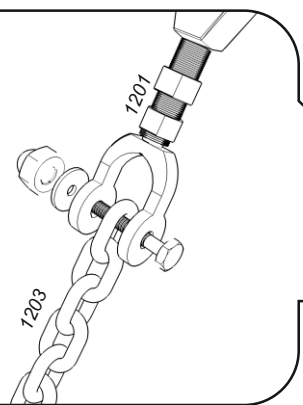

B

5

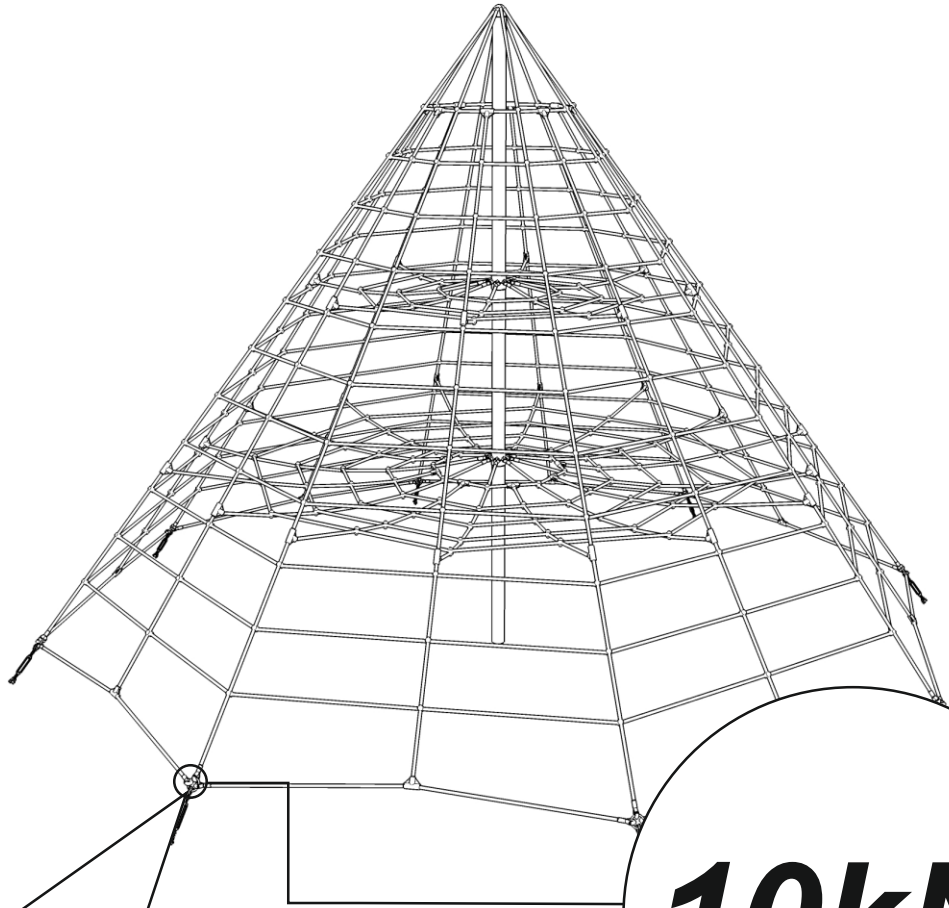

10kN!

8x

