

## INSTRUKCJA MONTAŻU INSTALLATION INSTRUCTIONS

nr kat. 0416  
art. N° 0416

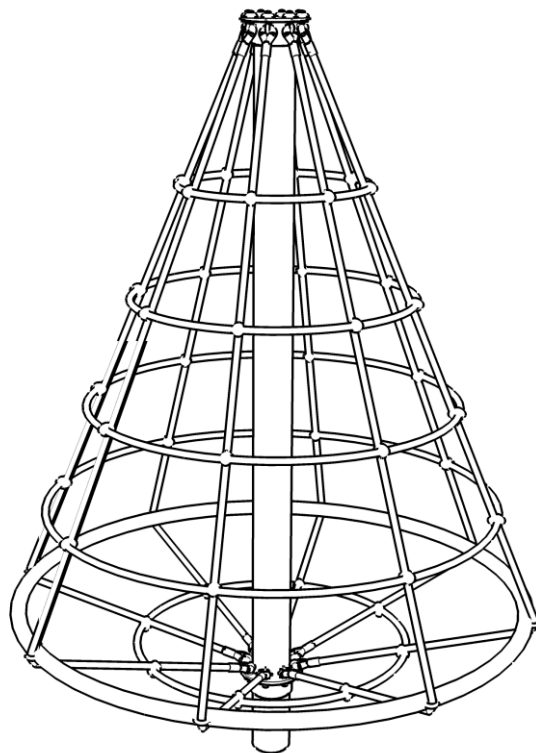

### STREFA BEZPIECZEŃSTWA

*safety zone*

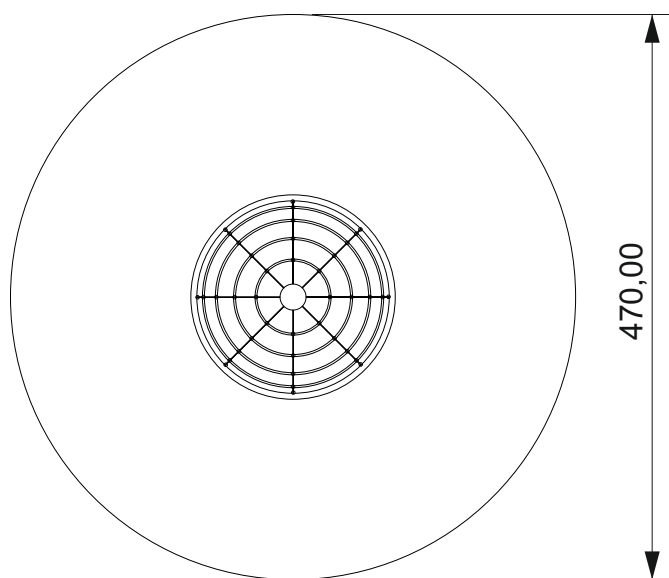

### WYMIARY URZĄDZENIA

*dimensions*

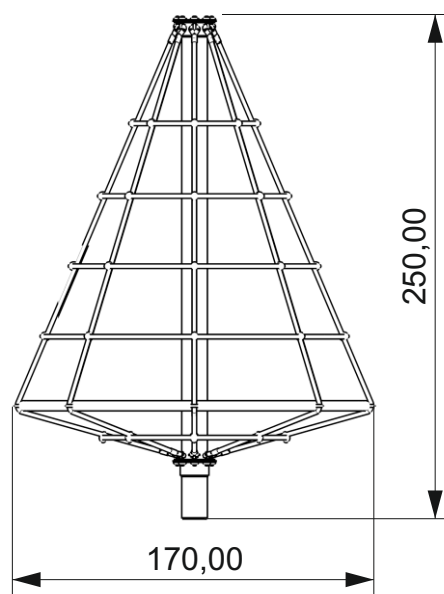

### NARZĘDZIA

*tools*

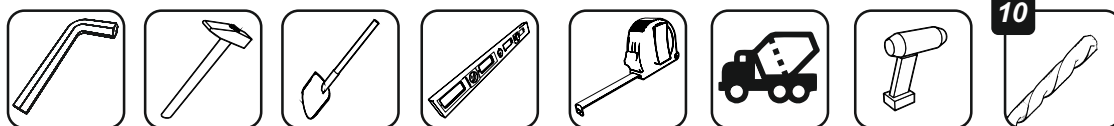

**FUNDAMENTY**  
basement

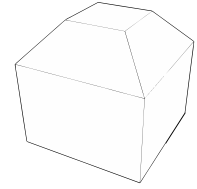
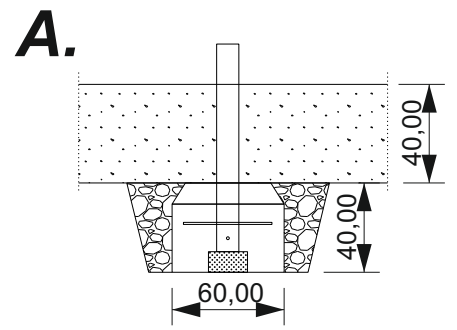
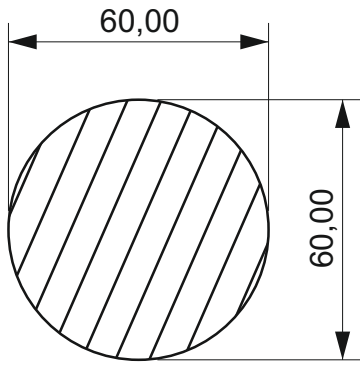
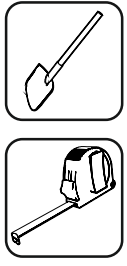

1x

60x60x40cm - 0,144 m<sup>3</sup>

**ELEMENTY SKŁADOWE**  
components

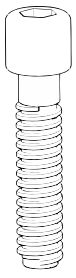

3x

1101 M10x40



1x

1201

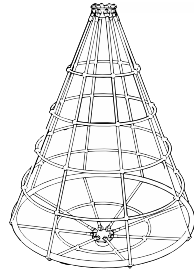

1x

1202

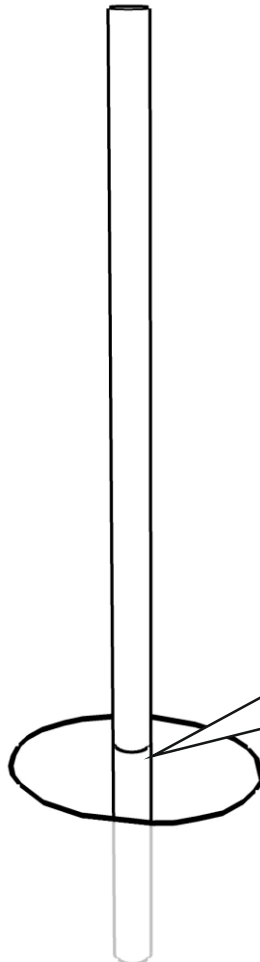

2

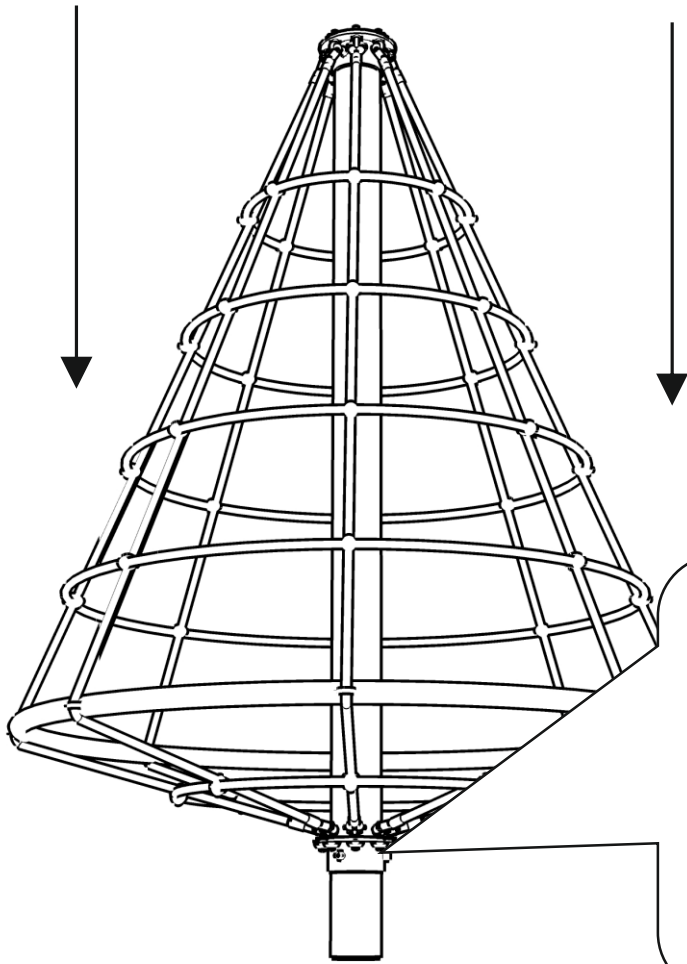
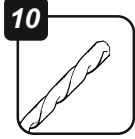
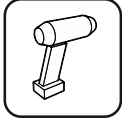

**150 kg**

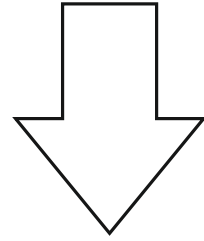

3

