

INSTRUKCJA MONTAŻU INSTALLATION INSTRUCTIONS

nr kat. 0409
art. N° 0409

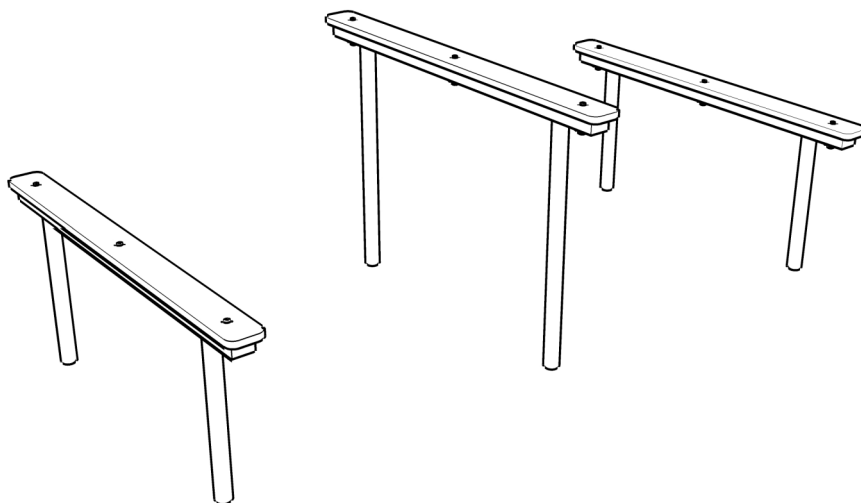

STREFA BEZPIECZEŃSTWA safety zone

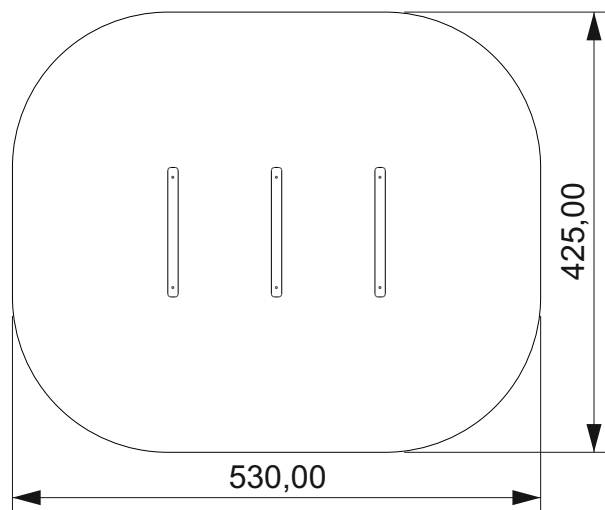

WYMIARY URZĄDZENIA dimensions

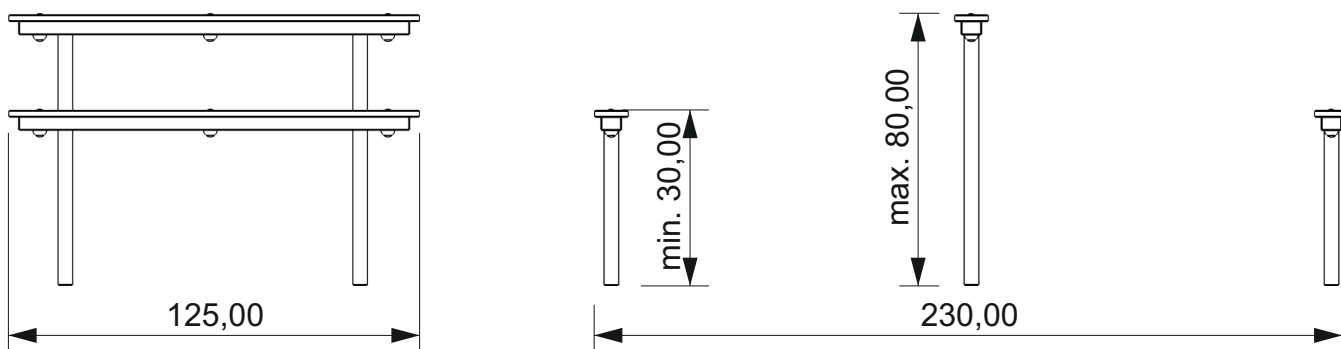

NARZĘDZIA tools

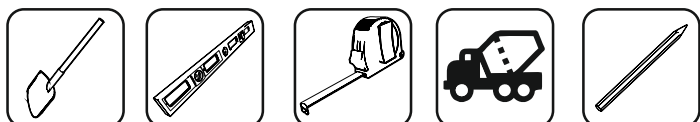

FUNDAMENTY

basement

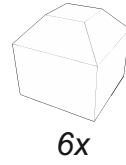
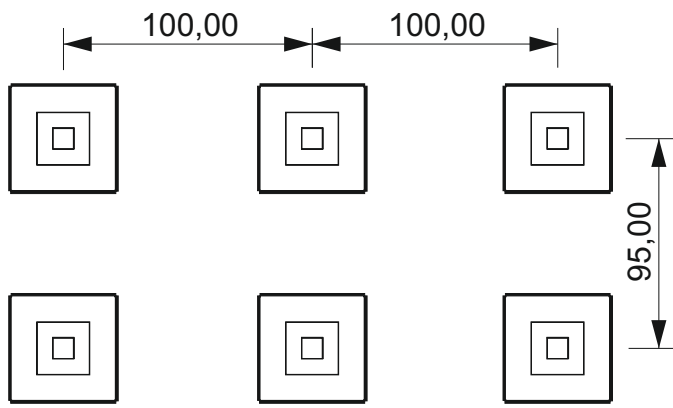
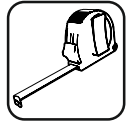

6x 0,06 m³

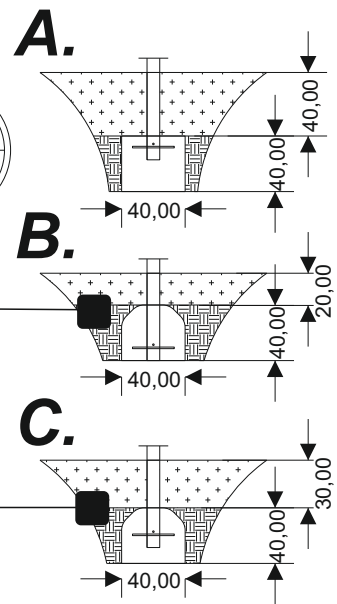

ELEMENTY SKŁADOWE

components

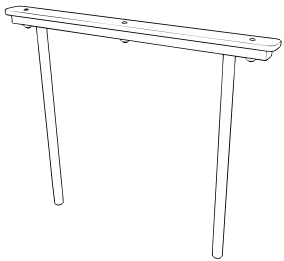

3x

