

INSTRUKCJA MONTAŻU INSTALLATION INSTRUCTIONS

nr kat. 0400
art. N° 0400

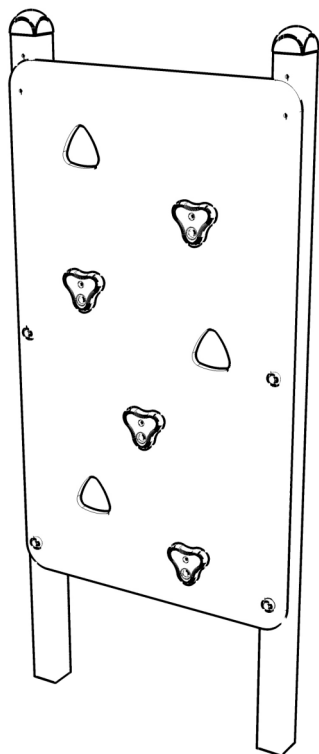

STREFA BEZPIECZEŃSTWA safety zone

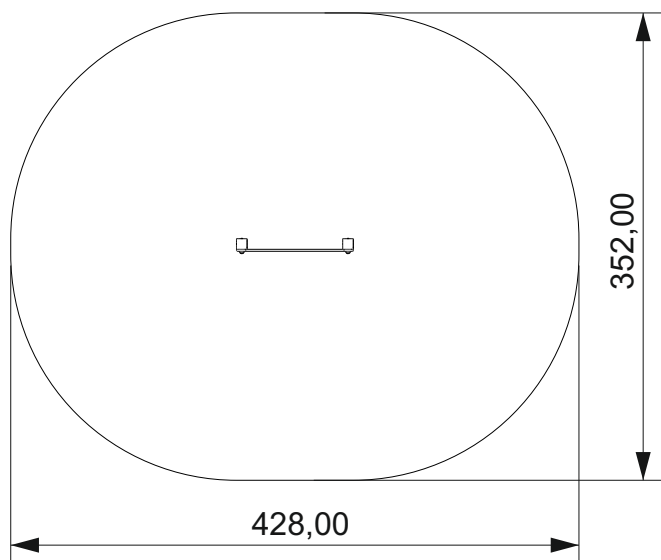

WYMIARY URZĄDZENIA dimensions

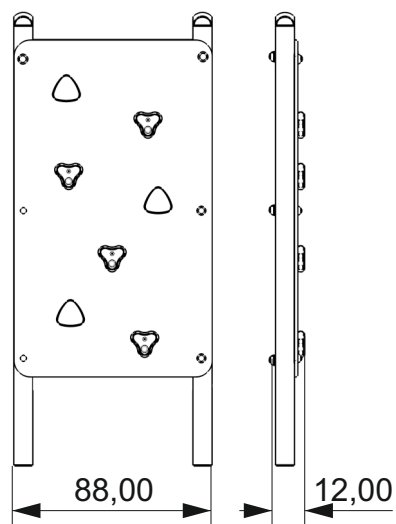

NARZĘDZIA tools

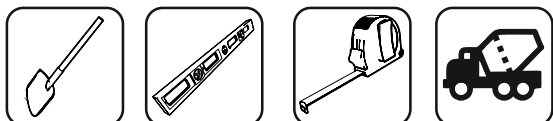

FUNDAMENTY
basement

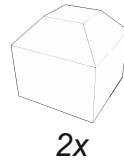
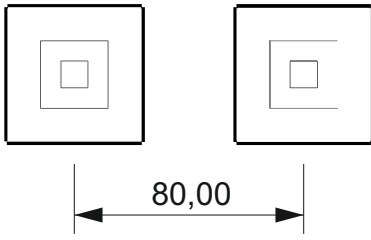
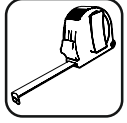

2x

0,06 m³

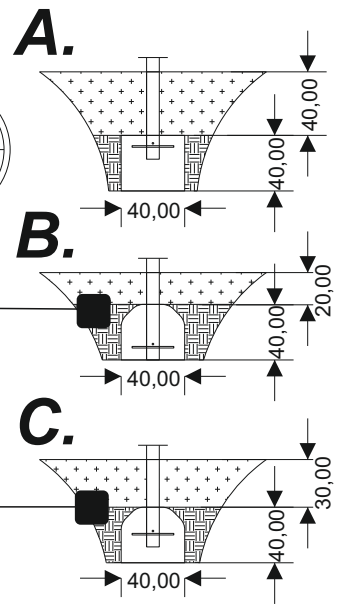

ELEMENTY SKŁADOWE
components

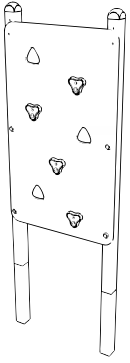

1x

